



VM[®] Lab Mixer User Manual



We don't just sell machines—
we provide service.

Copyright Notice

© LFA Machines Oxford Limited, published in 2026 by LFA Machines Oxford Limited 2026. Registered in England and Wales, company number 08428898, registered office for service Demar House 14 Church Road East Wittering, Chichester, West Sussex, PO20 8PS.

All rights reserved. No part of this publication may be reproduced or transmitted, in any form or by any means, or stored in any retrieval system of any nature, without prior permission, except for fair dealing under the Copyright, Designs and Patents Act 1988, or in accordance with the terms of license issued by the Copyright Licensing Agency in respect of photocopying and/or reprographic reproduction. Application for permission for other use of the copyright material including permission to reproduce extracts in other published works shall be made to the publisher. Full acknowledgment of author, publisher and source must be given.

All trade marks are acknowledged and are owned by their respective owners.

Important Safety Information

READ THIS BEFORE OPERATING MACHINE

Intended Use

The intended use of this machine is to thoroughly blend dry raw materials.

Potential misuse of this machine includes:

- Completely filling the Hopper with powder (over $\frac{2}{3}$ full).
- Not properly mounting the machine.
- Using explosive powders sensitive to movement.
- Using wet or damp material.

Personal Protection

For personal protection while transporting the VM[®] Lab Mixer, abide by these actions:

- Use an engine hoist or pallet jack to lift the machine.
- Wear steel toe boots to prevent foot injury.
- Wear heavy duty grip gloves to ensure firm grasp on machine.
- Wear back support belt to prevent injury if needed.

For personal protection while operating the VM[®] Lab Mixer, abide by these actions:

- Avoid wearing loose jewelry to prevent machine entanglement.
- Contain long hair to prevent machine entanglement.
- Wear safety goggles.
- Wear disposable latex/rubber gloves.
- Wear a hairnet (food grade products only).
- Wear a beard net if needed (food grade products only).

General Hazards

In the case of an emergency during operation, immediately push the Emergency Stop button.

- Be aware of risk of entanglement and pinch point due to moving parts.
- Do not operate in a wet environment or with wet hands due to risk of electrical shock or burn.
- Do not operate if any wires are exposed in cables due to risk of electrical shock or burn.
- Keep out of reach of children.
- Keep fingers away from all moving parts.
- Inspect machine before use.
- Check that nuts and bolts are suitably tightened.
- Use this machine only for its intended use as described in this manual.
- Do not modify the machine in any way.
- Turn off and unplug the machine before conducting cleaning and maintenance.

Important Safety Information

READ THIS BEFORE OPERATING MACHINE

Symbols



WARNING

This signals potential risk for personal injury.



WARNING

This signals potential risk for electrical shock.



CAUTION

This signals potential risk for damage to the machine or other parts.

Modes for Stopping

In the case of an emergency during operation, immediately unplug the VM[®] Lab Mixer and/or push the Emergency Stop button:



Prop. 65 Statement for CA Residents

Based on LFA's current level of knowledge of our machines, the VM[®] Lab Mixer does not require a Proposition 65 warning label.

Warning for Explosive Material

This machine is not explosion proof. LFA recommends that you test your materials' explosivity before running them through this machine. If your materials are indeed explosive, do not use them with this machine.

Important Safety Information

READ THIS BEFORE OPERATING MACHINE

Installation and Safety Assessment

Due to the nature and design of this machine and its intended use in an industrial environment, it is important that before use it is installed in a cage with a mode of stopping on the outside of the cage. LFA Machines has decided that we can not possibly foresee all of the environments or situations in which this machine could be used or installed and therefore have determined that the end user must install the machine in a way that is appropriate and safe for its use.

Once the machine has been installed, it is critical that you conduct a safety assessment to ensure that it complies with all local and industry accepted safety regulations.

If you require guidance on the installation of the machine or conducting a safety assessment, please contact LFA Machines.

This machine is sold as an Unfinished Machine under the Machinery Directive (2006/42 / EC) Article 13.

Table of Contents

Copyright Notice	2
Important Safety Information	3
Intended Use	3
Personal Protection	3
General Hazards	3
Important Safety Information	4
Symbols	4
Modes for Stopping	4
Prop. 65 Statement for CA Residents	4
Warning for Explosive Material	4
Installation and Safety Assessment	5
VM® Lab Mixer Components	7
VM® Lab Mixer Electrical Components	8
Preface	9
Training	10
Off-Site Training	10
Training via Video Chat/Phone	10
LFA Articles	10
LFA Videos	10
Installation	11
Tools and Materials Needed	11
The Appropriate Workstation for the Machine	11
Positioning the VM® Lab Mixer	13
Controls	14
Settings and Adjustment	18
Maintenance	19
General Maintenance Prescriptions	19
Lubrication	19
Dismantling for Repair and Replacement	22
Wear Parts and Causes of Damage	23
Troubleshooting	27
Common Machine Issues	27
Cleaning	28
Storing the VM® Lab Mixer	31
Appendix	32
Glossary	32
Description of VM® Lab Mixer Parts	33
Food Grade Point of Contact Parts	34
Technical Specifications	34
Maintenance Checklist	35
Diagrams	36
Resources	40

VM[®] Lab Mixer Components

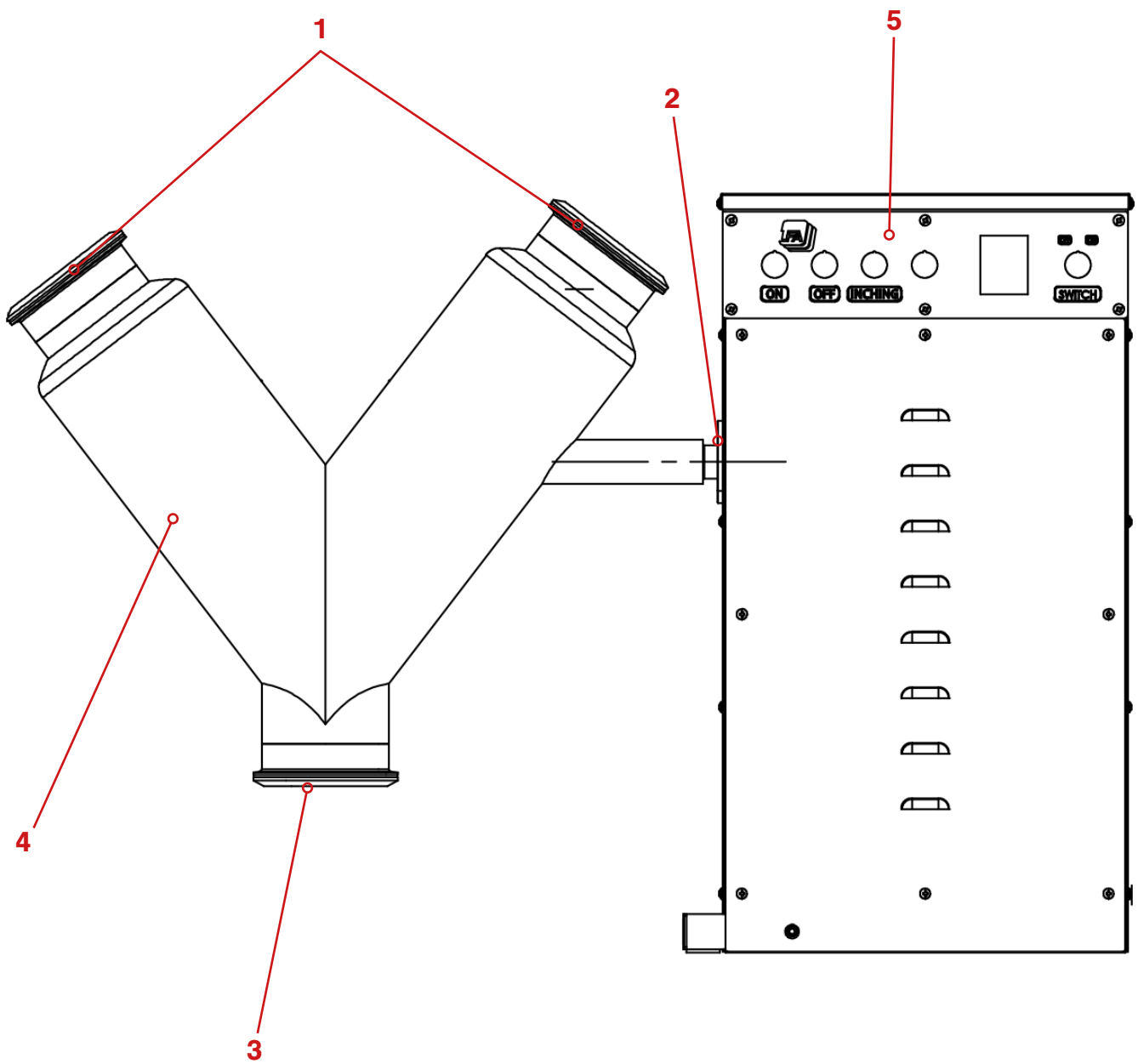

- 1. Feeder Points
- 2. Bushing
- 3. Discharge Chute

- 4. Hopper
- 5. Control Console

VM[®] Lab Mixer Electrical Components



- 1. Start machine operation**
- 2. Stop machine operation**
- 3. Operate machine in small increments**

- 4. Emergency stop**
- 5. Set operation time**

Preface



The VM[®] Lab Mixer is an excellent option for R&D and small batch production. With interchangeable hoppers available in sizes of 2 L, 10 L, and 15 L, the VM[®] Lab Mixer offers flexibility in its range of small batch production sizes. Possessing both an agitation speed of 28 rotations per minute as well as an average mixing time of 6-8 minutes, the VM[®] Lab Mixer integrates and blends powders efficiently and thoroughly with little effort and in a short amount of time.

Ideal for small businesses, R&D departments, and universities, the VM[®] Lab Mixer's compact floor plan makes it an accessible machine in the work area, when compared to larger, more obtrusive mixers.

The purpose of this document is to support your understanding of the VM[®] Lab Mixer range's components, features, functions, and design. With this manual, you will be able to successfully operate and maintain your VM[®] Lab Mixer machine.

The user manual's content includes:

- Important safety information
- VM[®] Lab Mixer installation instructions
- Description of the VM[®] Lab Mixer operation
- VM[®] Lab Mixer maintenance information
- Appendix with supplemental information

Training

VM[®] Lab Mixer training is essential for the machine's successful operation and your personal safety. There are several methods to prepare you for working with the VM[®] Lab Mixer.

Off-Site Training

LFA offers training at our UK, USA, and Taiwan facilities for all our customers and their teams. For more information, go to <https://www.lfatabletpresses.com/services>

Training via Video Chat/Phone

Using an online video chat system, an LFA technician can interact face-to-face with you and assist with your understanding of the machine. Or, if you prefer, LFA can provide training via phone for all customers who call the office. To set up a training, call or email your local LFA office:

UK

Phone

+44 01869 250234

Email

support.uk@lfamachines.com

USA

Phone

+1 (682) 312-0034

Email

support.usa@lfamachines.com

Taiwan

Phone

+886 422031790

Email

support.asia@lfamachines.com

LFA Articles

LFA writes informative articles about our machines, which includes instructions, procedures, and guides. To access the articles, go to <https://www.lfatabletpresses.com/articles> or <https://www.lfacapsulefillers.com/articles>

LFA Videos

LFA has created several videos involving the VM[®] Lab Mixer and other machines. To access the videos, go to <https://www.lfatabletpresses.com/videos> or <https://www.youtube.com/user/TabletPilPress>

Installation

Tools and Materials Needed

Before you install and operate the VM[®] Lab Mixer, it is best to have the following tools and materials on hand for general operation and maintenance:

- Engine hoist/pallet jack
- Lifting strap
- Hammer
- Crowbar
- Metric wrench set
- Container to catch mixed powder from machine
- Crosshead screwdriver
- Flathead screwdriver
- Set of metric Allen keys with ball ends
- Cleaner (e.g. Member's Mark Commercial Lemon Disinfectant)
- Sanitizer (e.g. Member's Mark Commercial Sanitizer)
- Lubricant (NSF approved type for food grade products)
- Toothbrush
- Cleaning brush set
- Plastic sheet or something similar to cover machine
- Safety goggles
- Hairnet and/or beard net (food grade products only)
- Sterile shoe covers (food grade products only)

The Appropriate Workstation for the Machine

The floor on which the machine is to be placed must support the VM[®] Lab Mixer's weight.

Machine Weight and Floor Loading (Static)		
VM [®] Lab Mixer 2	63 kg (140 lbs)	0.159 kN/m ²
VM [®] Lab Mixer 10	74 kg (164 lbs)	0.187 kN/m ²
VM [®] Lab Mixer 15	76 kg (170 lbs)	0.192 kN/m ²

The VM[®] Lab Mixer motors requires a single-phase power supply of 240 V (UK) or 110 V (USA).

Environmental Conditions

It is important that the environment in which you operate and store the VM[®] Lab Mixer has the appropriate temperature and relative humidity levels. These two environmental factors can potentially cause the machine to rust and/or cause low quality in powder mixtures.

Appropriate Environmental Conditions			
Machine	Temperature		Humidity
VM [®] Lab Mixers	°C	°F	45-65% RH
	18-24	64-75	

Unpacking the VM[®] Lab Mixer

Tools Needed

- Crowbar
- Hammer

Instructions

1. Pry open the shipping container with a crowbar.
2. Remove the machine from the shipping container's base.
 - 2.1 Note: Keep the nuts, bolts, and the shipping container's base in case you need to move or relocate the VM[®] Lab Mixer.

READ BEFORE INSTALLATION:

Depending on local health and safety laws, the VM[®] Lab Mixer may be required to be installed in a cage. A risk assessment is required to be conducted before installation and operation of the machine.

LFA Machines is able to advise on this. Please contact us for more information:

UK

Phone

+44 01869 250234

Email

support.uk@lfamachines.com

USA

Phone

+1 (682) 312-0034

Email

support.usa@lfamachines.com

Taiwan

Phone

+886 422031790

Email

support.asia@lfamachines.com

Positioning the VM[®] Lab Mixer



WARNING: To prevent personal injury, wear steel toe boots and heavy duty grip gloves while transporting the VM[®] Lab Mixer.

LFA does NOT recommend carrying the machine manually but rather with a engine hoist or pallet jack. At least two people should be involved (one operating the engine hoist/pallet jack and one stabilizing the machine) in removing the machine from the shipping container and placing it in the workspace.

Moving the VM[®] Lab Mixer

Tools Needed

- Engine hoist/pallet jack
- Lifting strap that supports VM[®] Lab Mixer's weight (engine hoist)
- Heavy duty grip gloves
- Steel toe boots

Instructions

1. Wrap the lifting strap around the VM[®] Lab Mixer's base and top.
2. Attach the lifting strap to the engine hoist/pallet jack.
3. Carefully raise the VM[®] Lab Mixer and guide it to the desired location.
 - 3.1 Note: The VM[®] Lab Mixer requires a single-phase power supply of 110 V (USA or 240 V (UK).
4. Carefully lower the VM[®] Lab Mixer until it is placed in the desired location.
5. Plug in the machine to an outlet.

VM[®] Lab Mixer Assembly

Tools Needed

- Contents inside of shipping container (Hopper and machine base with motor)
- Set of metric Allen keys with ball ends

Instructions

1. Unwrap the Hopper from its plastic wrapping.
2. Place the Hopper on the Main Cam Drive Shaft.
3. Insert the set screw and tighten it with an Allen key.
4. Plug in the machine to an outlet.



Controls

Basic Components

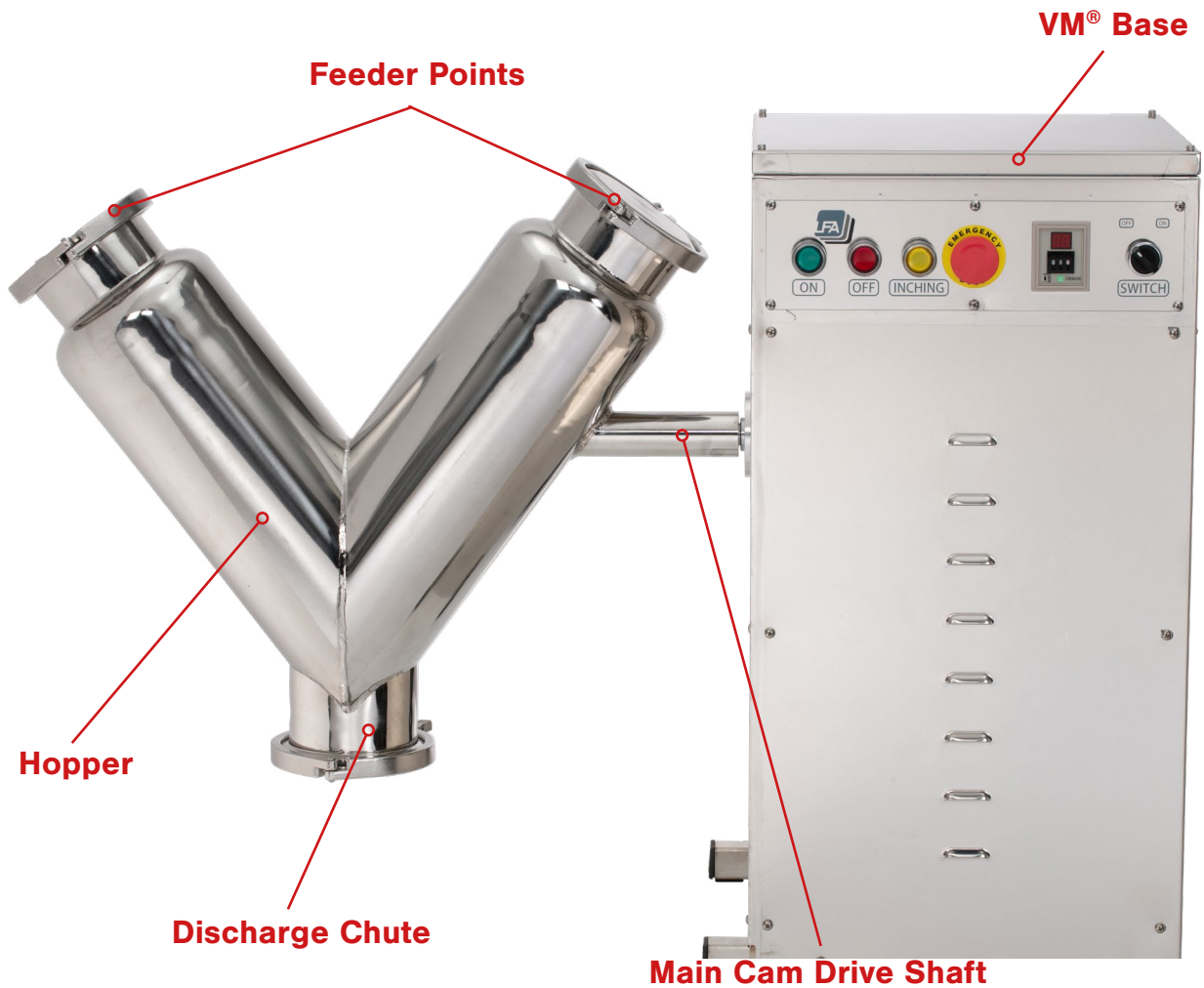

A description of the principal components follows:

- The **Feeder Points** are where the dry materials to be mixed are poured.
- The **Hopper** contains the powder that is mixed.
- The **Discharge Chute** allows the mixed powder to be expelled from the Hopper.
- The **Main Cam Drive Shaft** connects the Hopper to the main base of the machine.
- The **VM® Base** has a control console and also contains the Motor, V Belt, and Drive Belt Pulleys.

VM[®] Lab Mixer Process

The basic mechanism of the VM[®] Lab Mixer involves filling one of the Feeder Points, selecting a running time, and turning on the machine.

Filling the Hopper with Powder

The Hopper is filled with powder (up to $\frac{2}{3}$ full) through one of the Feeder Point's inlets.

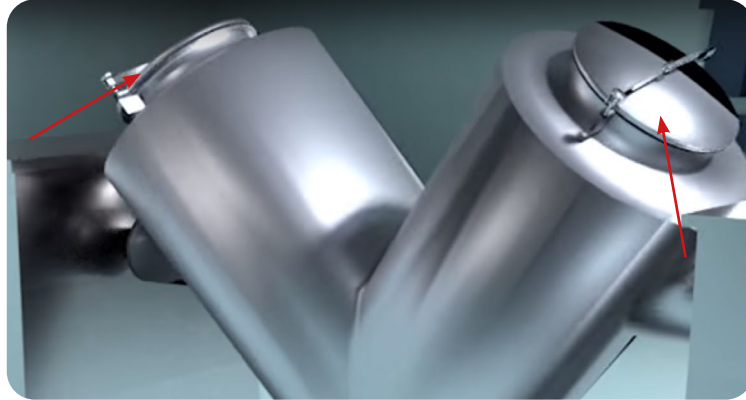

Rotating the Hopper to Mix the Powder

After the Hopper is filled with powder, the machine is set to run a certain amount of time. Once the machine is turned on, the Hopper rotates so that the powder can be thoroughly mixed.

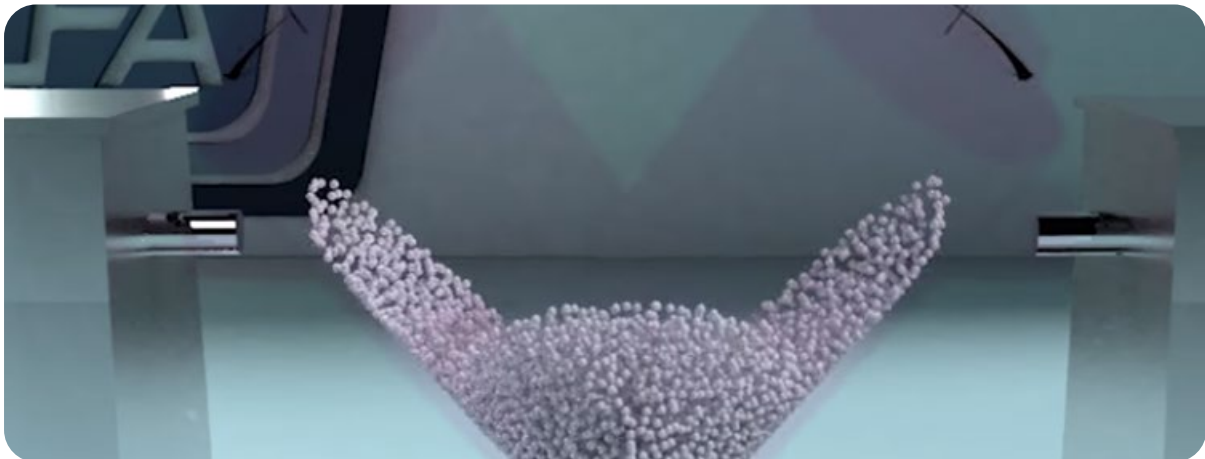

Releasing the Mixed Powder

Once the machine has stopped operating and is in the upright position, the mixed powder can be released from the Discharge Chute into a container.

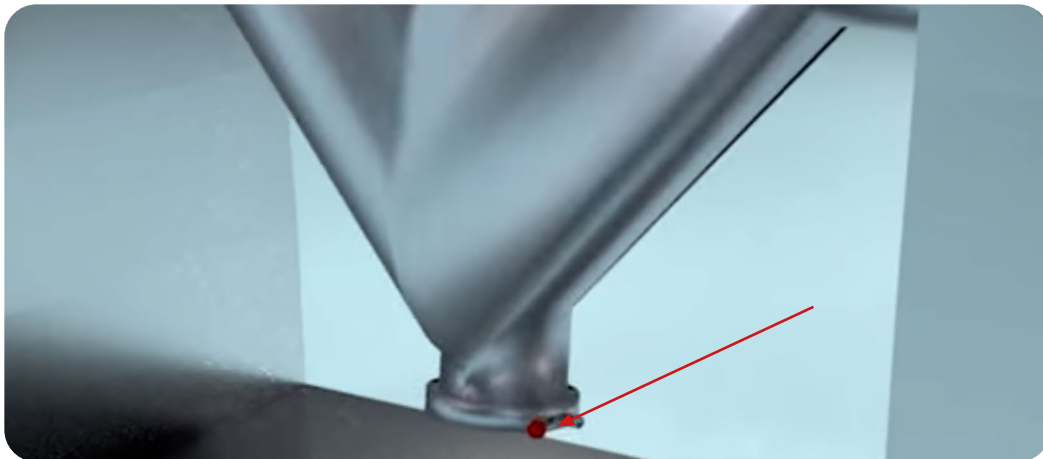

Fill Volumes

The VM[®] Lab Mixer works on fill volume, rather than maximum weight capacity of the Hopper, because the weight of a powder mix can vary depending on its bulk density.

The maximum fill volume represents only a percentage of the total volume of the Hopper and is dependent on a combination of the bulk density and volume of the powder product.

Calculating Bulk Density

Tools and Materials Needed

- Raw material formulation
- Measuring apparatus (e.g. 1 liter cylinder)
- Scale

Instructions

Note: Wear latex/rubber gloves (and appropriate food grade attire if applicable) during this process.

1. Place the measuring apparatus onto the scale.
 - 1.1 Note: Ensure that the scale displays zero.
2. Fill the measuring apparatus with powder to the top.
 - 2.1 Note: Ensure not to tap down or disturb the powder while it is being poured.
3. Record the weight of the powder in mL.
4. Divide the weight of the powder by the volume of the measuring apparatus in mL.

Resources for Calculating Bulk Density

To help with calculating bulk density of a powder, LFA offers two resources on our website.

To watch a video on how to calculate the loose bulk density of a powder, go to <https://www.lfatabletpresses.com/videos/calculating-bulk-density-making-a-tablet-pill-mix>

To see further information on bulk density and use our bulk density calculator, go to <https://www.lfatabletpresses.com/bulk-density-calculator>

How to Mix Powder with the VM[®] Lab Mixer

Tools and Materials Needed

- Raw material formulation
- VM[®] Lab Mixer
- Container for mixed powder
- Safety goggles
- Disposable latex/rubber gloves (for food grade products and to protect hands from grease)
- Hairnet and/or beard net (food grade products only)
- Sterile shoe covers (food grade products only)



WARNING: For personal protection while operating the VM[®] Lab Mixer, contain long hair and do not wear loose jewelry

Instructions

Note: Wear latex/rubber gloves (and appropriate food grade attire if applicable) during this process.

1. Remove one of the Hopper's feeder point clamps by loosening its thumb screw and remove the feeder point's lid.

2.1 Note: Ensure that the discharge chute is closed before pouring the material.

2. Pour in the powder material until the Hopper is $\frac{2}{3}$ full and re-secure the feeder point lid and clamp.

3. Press the ON (green) button to begin operation.



4. Place a container underneath the Hopper's discharge chute.

5. Press the OFF (red) button to end operation.

6. Open the discharge chute by loosening the clamp thumbscrew and remove the lid to release the mixed powder into the container.



Settings and Adjustment

Some VM[®] Lab Mixer settings can be adjusted.

Operation Time

The VM[®] Lab Mixer has a setting that will allow the Hopper to rotate for a determined amount of time.

The operation time should be calculated by mix validation, which is establishing that a specific process or equipment will consistently produce a product or result. To watch a video on how to perform a mix validation, go to <https://www.lfatabletpresses.com/videos/mix-validation-making-a-tablet-mix>

Tools and Materials Needed

- Disposable latex/rubber gloves (for food grade products and to protect hands from grease)
- Hairnet and/or beard net (food grade products only)
- Sterile shoe covers (food grade products only)



WARNING: For personal protection while operating the VM[®] Lab Mixer, contain long hair and do not wear loose jewelry

Instructions

Note: Wear latex/rubber gloves (and appropriate food grade attire if applicable) during this process.

1. Press the buttons to make adjustments to the time settings.



- 1.1. Note: The two leftmost buttons are for the amount of time. The right button switches between units of time (S = seconds, M = minutes, H = hours).
2. Press the ON (green) button to start operation.
 - 2.1 Note: If you want to turn off the timer, stop machine operation and turn all settings to 0.

Maintenance

To ensure that the VM[®] Lab Mixer will have a long operational life, maintenance is essential. This section includes methods for replacing parts, troubleshooting solutions, and how often to grease and clean your machine to keep its performance optimal.

General Maintenance Prescriptions

- Use the maintenance checklist (found in the Appendix) before, during, and after machine operation.
- Make sure all grease points are maintained and regularly lubricated.
- Use an appropriate amount of lubricant.
- Before reassembling the machine after cleaning, make sure that the parts are dried and oiled.
- Constantly check for any loose nuts and/or screws before, during, and after machine operation.
- If the machine is not used for more than a week, cover it with a plastic sheet.

Lubrication

Regularly greasing your machine is vital to prolonging its operational life. Parts that are not greased properly can make the machine seize up and cause major problems later. LFA recommends maintaining a lubrication schedule for your VM[®] Lab Mixer, which can be found in this section.

Tools and Materials Needed

- NLGI Grade 2
- 460 Grade Worm Gear Oil
- Disposable latex/rubber gloves (for food grade products and to protect hands from grease)
- Hairnet and/or beard net (food grade products only)
- Sterile shoe covers (food grade products only)



WARNING: To prevent any potential personal injury, unplug the VM[®] Lab Mixer from the electrical outlet.

Instructions

Note: Wear latex/rubber gloves (and appropriate food grade attire if applicable) during this process.

1. Apply NLGI Grade 2 grease to the bushing on the Main Cam Drive Shaft.



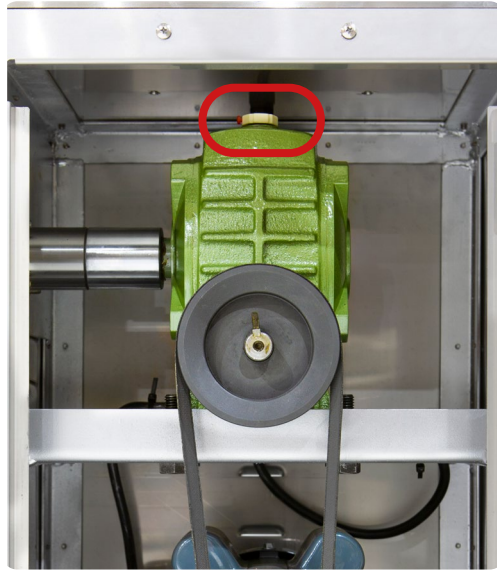

2. Inspect the Gearbox's oil window on its side and see if the oil is below the minimum line. If it is, top it up with 460 Grade Worm Oil.



Lubrication Schedule

LFA recommends the following VM[®] Lab Mixer parts to be lubricated according to the following frequency:

Part	Location	Image	Frequency	Type of Lubricant
Bushing on Main Cam Drive Shaft	Bushing that connects the Hopper to the VM [®] Lab Mixer's base		Apply grease in the following situations: 1) After every 100 hours of use, 2) after a deep clean, or 3) if returning to use the machine after a prolonged period of time.	NLGI Grade 2 H2 for food product
Gearbox	Inside the VM [®] Lab Mixer's base and above the Motor.		Check the oil inspection window every month and top up if required.	460 Grade Worm Gear Oil

Dismantling for Repair and Replacement

Eventually due to wear and tear, some parts of the VM[®] Lab Mixer will need to be removed for repair and replacement. To prevent any delays in your production, it is best practice to keep extra parts just in case.

Warranty

To access LFA's warranty policy, go to <https://www.lfatabletpresses.com/warranty>

If your part is eligible for warranty, have your part's serial number on hand and please contact LFA:

UK

Phone

+44 01869 250234

Email

support.uk@lfamachines.com

USA

Phone

+1 (682) 312-0034

Email

support.usa@lfamachines.com

Taiwan

Phone

+886 422031790

Email

support.asia@lfamachines.com

For distributor contact information, go to

<https://www.lfamachines.com/contact>



WARNING: To prevent any potential personal injury, ALWAYS unplug the VM[®] Lab Mixer from the electrical outlet when replacing parts.

Wear Parts and Causes of Damage

Wear Part	Cause of Damage
V Belt	The V Belt for the VM [®] Lab Mixer drives all of the power from the motor to the Hopper via the Gearbox. Overtime, this will lose some of its tension and wear, causing the belt to slip, which affects the mixer's ability to handle the maximum weight capacity.
Bushing	Each VM [®] Lab Mixer will have a bushing to support the mixing barrel. If powder builds up around the bushing, or if it is not cleaned and/or lubricated properly, it can wear overtime.

Input Gaskets and Output Gasket

The Input Gaskets are located on top of both sides of the Hopper. The Output Gasket is located in the discharge chute's opening. The inlet/outlet lids and locking rings must be removed in order to access the Input Gaskets.

Tools and Materials Needed

- New Input Gaskets/Output Gasket
- Disposable latex/rubber gloves (for food grade products and to protect hands from grease)
- Hairnet and/or beard net (food grade products only)
- Sterile shoe covers (food grade products only)



WARNING: To prevent any potential personal injury, ALWAYS unplug the VM® Lab Mixer from the electrical outlet when replacing parts.

Instructions

Note: Wear latex/rubber gloves (and appropriate food grade attire if applicable) during this process.

Remove the Gaskets

1. Loosen the clamp thumbscrews from the inlets/outlet.



2. Remove the Input Gaskets/Output Gasket from the Hopper's inlets/outlet.

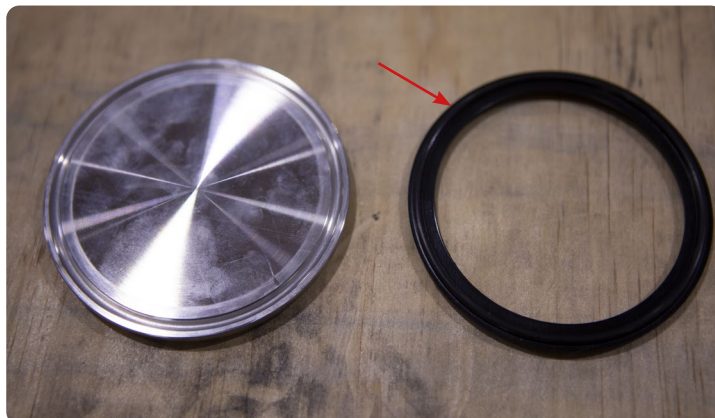

Replace the Gaskets

3. Insert the new Gaskets into the Hopper inlets/outlet.
4. Reinsert the Hopper lids and tighten the clamp thumbscrews.

Timer

The Timer on the VM® Lab Mixer can be removed and replaced. To do this, the Timer's plastic wires must be disconnected from the machine.

Tools and Materials Needed

- Crosshead screwdriver
- New Timer
- Disposable latex/rubber gloves (for food grade products and to protect hands from grease)
- Hairnet and/or beard net (food grade products only)
- Sterile shoe covers (food grade products only)



WARNING: If you do not have sufficient experience in wiring electrical items, do NOT attempt to replace this part at the risk of electrical shock.
Turn off and unplug the machine before replacing this part.

Instructions

Note: Wear latex/rubber gloves (and appropriate food grade attire if applicable) during this process.

Remove the Timer

1. Loosen the screws on the top panel with a crosshead screwdriver to remove it.



Note: Before removing the wires, it is recommended to take a photo or make note of the wires' placement.

2. Unclip the Timer from the machine's wiring.
3. Remove the Timer from the machine.

Replace the Timer

4. Insert the new Timer into the machine.
5. Clip the new Timer onto the machine's wiring.

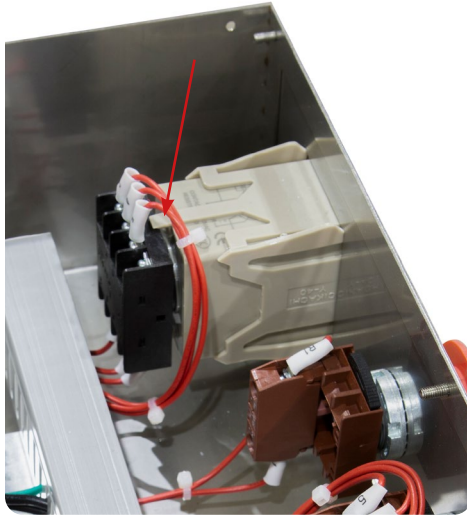

6. Place the top panel back on the base and resecure its screws with a crosshead screwdriver.

Troubleshooting

Sometimes unavoidable issues will occur while operating the VM[®] Lab Mixer. Fortunately, there are several methods to remedy these issues.

Common Machine Issues

Symptom	Possible Cause	Possible Solution
Powder takes too long to mix	The fill volume in the Hopper is too high.	Reduce the amount of powder in the Hopper (does not exceed $\frac{2}{3}$ full).
	There is not enough operation time for the powder to be mixed.	Increase the amount of operation time on the Timer.
	The Hopper was incorrectly filled with powder.	Ensure to fill the Hopper with horizontal layers of powder, rather than vertical.
	The particle properties in the powder are too different.	Eliminate solids/different particle sizes by granulating or milling the powder before mixing.
Knocking sounds coming from machine	The V Belt is loose.	Tighten the V Belt.
	Parts may be loose.	Check the machine's parts and tighten as necessary.
Heavy resistance during production	The high friction areas are either unclean, locked, worn out, or not greased properly.	Apply grease to all high friction areas and/or clean the machine.
Excess machine vibration	The V Belt is worn.	Replace the V Belt.
	The machine has no anti-vibration pads or they are worn.	Place new anti-vibration pads on the bottom of the machine.
	Parts may be loose.	Check the machine's parts and tighten as necessary.
The Hopper is not turning	The Main Cam Drive Shaft is loose.	Tighten the the bolt that secures the Main Cam Drive Shaft.
	The V Belt is loose.	Tighten the V Belt.
	The Gearbox is jammed.	Replace the Gearbox.

Cleaning

During the VM[®] Lab Mixer's operation, excess powder will find its way into parts of the machine. It is important to clean the VM[®] Lab Mixer thoroughly to prevent rusting and cross contamination.

LFA recommends that the machine be cleaned after each operation.

Tools and Materials Needed

- Set of metric Allen keys with ball ends
- Crosshead screwdriver
- Cleaning brush
- Bagless vacuum
- Toothbrush
- Cleaner (e.g. Member's Mark Commercial Lemon Fresh Disinfectant)
- Sanitizer (e.g. Member's Mark Commercial Sanitizer) or 70%+ alcohol
- Disposable latex/rubber gloves
- Bowl of warm soapy water (nothing abrasive)
- 3 clean cloths
- Potable water
- Hairnet and/or beard net (food grade products only)
- Sterile shoe covers (food grade products only)



WARNING: To prevent any potential personal injury, ALWAYS unplug the VM[®] Lab Mixer from the electrical outlet when cleaning the machine.

Instructions

Note: Wear latex/rubber gloves (and appropriate food grade attire if applicable) during this process.

Remove Parts

1. Remove the Hopper from the machine.
2. Remove the panels.
3. Use a brush to bring powder debris out from hard to reach places.
4. Vacuum the top section of the VM[®] Lab Mixer base.
5. Vacuum the entire areas inside the steel side panel door encasement.
 - 5.1 Note: Be sure to thoroughly vacuum inside the VM[®] Lab Mixer's base.

Clean the VM[®] Lab Mixer

6. Take a clean cloth and carefully wash the Hopper thoroughly with soapy water.
 - 6.1 Note: Use the toothbrush for difficult-to-remove debris.
7. Dry the Hopper immediately after it is cleaned and rinsed.
8. Sanitize the Hopper with a clean cloth.



Clean the Base

9. Spray the outside and inside of the VM[®] Lab Mixer base with the cleaner.
10. Rinse the cleaner off with potable water.
11. Sanitize the outside and inside of the VM[®] Lab Mixer base with a clean cloth.



Cleaning Schedule Matrix

Part	After Installing Machine	After Every Use	Before Every Use	In Between Products That Present A Cross Contamination Risk	Weekly	Monthly	Before Placing In Storage	After Removing From Storage
Hopper	Remove from machine	Remove from machine	Install into machine	Remove from machine	N/A	N/A	Remove from machine	Install into machine
Base (outside)	Remove from machine	Remove from machine	Install into machine	Remove from machine	N/A	N/A	Remove from machine	Install into machine
Motor	Clean on machine	Clean on machine	N/A	Clean on machine	N/A	N/A	Clean on machine	Clean on machine

Cleaning Level Key	
Level 1 - Remove powder	
Level 2 - Dry clean with cloth	
Level 3 - Dry clean and re-lubricate if specified in lubrication schedule	
Level 4 - Wet clean and re-lubricate if specified in lubrication schedule	
Remove from machine - Take part out of machine and clean if required. Store it correctly or install back into machine.	
Install into machine - Install part into the machine and make sure that it has been cleaned. If needed, lubricate to the level required.	
Clean on/in machine - Clean the part while in the machine and do not remove it. Make sure that all contact surfaces are clean to the level required.	

This cleaning matrix is intended as a guide only and is not an exhaustive list. All cleaning schedules will need to be adapted to the industry and product, following industry regulations and the material safety data sheets that come with specific products. Please check with your Food Safety Manager/Department, Quality Control Manager/Department, or other relevant internal departments at your company before using.

Storing the VM[®] Lab Mixer

After its thorough cleaning, the VM[®] Lab Mixer needs to be stored in the proper conditions. It is important to store it in an environment in which the machine is safe from rusting. The VM[®] Lab Mixer's high-traction areas need to be lubricated before you store the machine.

Tools and Materials Needed

- Plastic wrapping to cover machine
- Lubricant/grease (NSF approved lubricant if machine has a high chance of contact with the food or drug product)
- Disposable latex/rubber gloves (for food grade products and to protect hands from lubricant)
- Hairnet and/or beard net (food grade products only)
- Sterile shoe covers (food grade products only)

Instructions

Note: Wear latex/rubber gloves (and appropriate food grade attire if applicable) during this process.

Lubricating the High-Traction Areas

1. Apply NLGI Grade 2 grease to the bushing on the Main Cam Drive Shaft.



Environmental Conditions

It is important that the environment in which you store the VM[®] Lab Mixer has the appropriate temperature and relative humidity levels. These two environmental factors can potentially cause the machine to rust and/or cause low quality in powder mixtures.

Appropriate Environmental Conditions			
Machine	Temperature		Humidity
	VM [®] Lab Mixer	°C	
18-24		64-75	45-65% RH

Appendix

Glossary

Term	Definition
API/Active Pharmaceutical Ingredient	Any substance or mixture of substances used that is an active ingredient in the drug product.
Hopper	The v-shaped container in which powder is mixed.
Binding agent	See excipient.
Excipient	An inactive substance that serves as the vehicle or medium for a drug or other API.
Formulation	Powder mix of the excipient and the API that is compressed to make tablets.
Granular material	See Formulation.

Description of VM[®] Lab Mixer Parts

Hopper

The Hopper is the container in which the powder is contained and later mixed. The approximate fill volume capacity of the Hoppers is a range of 2 L, 10 L, and 15 L.



Input and Output Gaskets

The Input Gaskets are a rubber seals that are located on top of the Hopper and around the feeder points.



Clamp

The Clamp secures the input and output lids to the Hopper.



Timer

The Timer is a numerical dial that can be adjusted to set the running time for the machine.



Food Grade Point of Contact Parts

Contact Part	Material
Hopper (including feeder points and discharge chute)	SUS316

Technical Specifications

Model	VM® Lab Mixer 2	VM® Lab Mixer 10	VM® Lab Mixer 15
Barrel capacity	2 L / 0.07 ft ³	10 L / 0.35 ft ³	15 L / 0.53 ft ³
Approximate working capacity (volume)	0.8-1.2 L / 0.03 - 0.04 ft ³	5.6-8.4 L / 0.2-0.3 ft ³	6-9 L / 0.21-0.23 ft ³
Agitation speed (r/min)	28		
Average mixing time (min)	6-8		
USA Power	0.37 kW, 1 phase, 110 V		
UK Power	0.37 kW, 1 phase, 240 V		
Dimensions in box (mm)	1190 x 490 x 874		
Dimensions (mm)	783 x 378 x 683	973 x 378 x 683	1030 x 378 x 683
Dimensions with suggested working clearance (mm)	2090 x 1390 x 1774		
Machine weight (kg / lbs)	63 kg / 140 lbs	74 kg / 164 lbs	76 kg / 170 lbs

Maintenance Checklist

Before Operation	
<input type="checkbox"/>	Visually inspect the VM [®] Lab Mixer and the parts.
<input type="checkbox"/>	Ensure all nuts and bolts are tight.
<input type="checkbox"/>	Visually inspect lubrication points and grease where necessary.
<input type="checkbox"/>	Inch/jog the machine without powder.
<input type="checkbox"/>	Visually inspect electrical wires for any damage.
During Operation	
<input type="checkbox"/>	Listen for irregular knocking or clicking sounds. If heard, stop operation and inspect the VM [®] Lab Mixer's interior.
<input type="checkbox"/>	Occasionally check the Motor's temperature. If it starts to overheat, turn off the machine, let it cool down, and grease it to ensure smooth operation.
<input type="checkbox"/>	Check to see that the Emergency Stop properly works.
After Operation	
<input type="checkbox"/>	Unplug machine and remove all excess powder with a bagless vacuum.
<input type="checkbox"/>	Remove the Hopper and thoroughly clean its interior and exterior.
<input type="checkbox"/>	Wipe down the other surfaces with a damp cloth.
<input type="checkbox"/>	Apply a layer of NSF approved grease to the high-traction areas.

Diagrams

VM® Lab Mixer Electrical Diagram

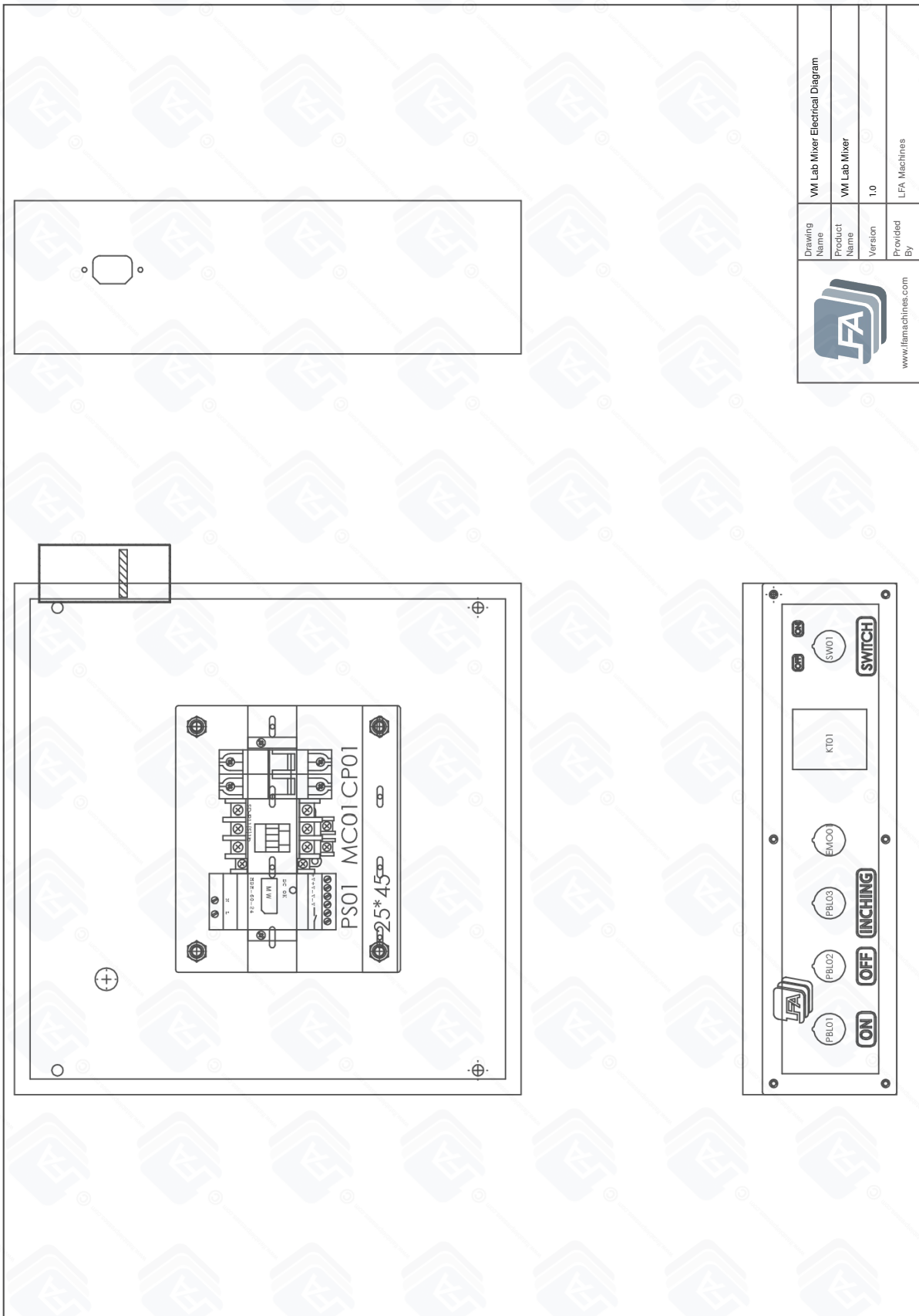

Diagrams

VM® Lab Mixer Electrical Diagram 2

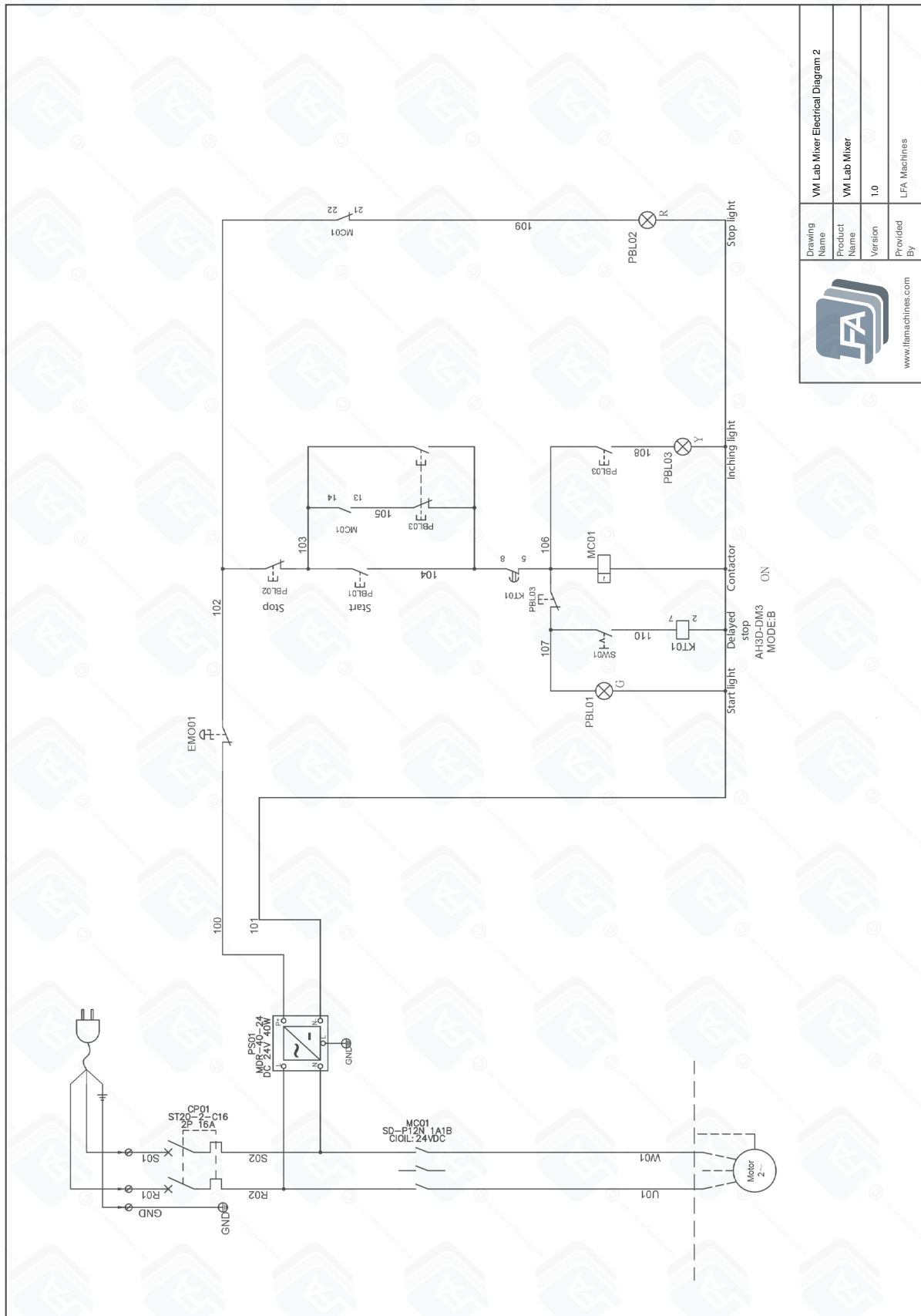

Drawing Name	VM Lab Mixer Electrical Diagram 2
Product Name	VM Lab Mixer
Version	1.0
Provided By	LFA Machines

www.lfamachines.com

VM® LMH 2 Dimensions

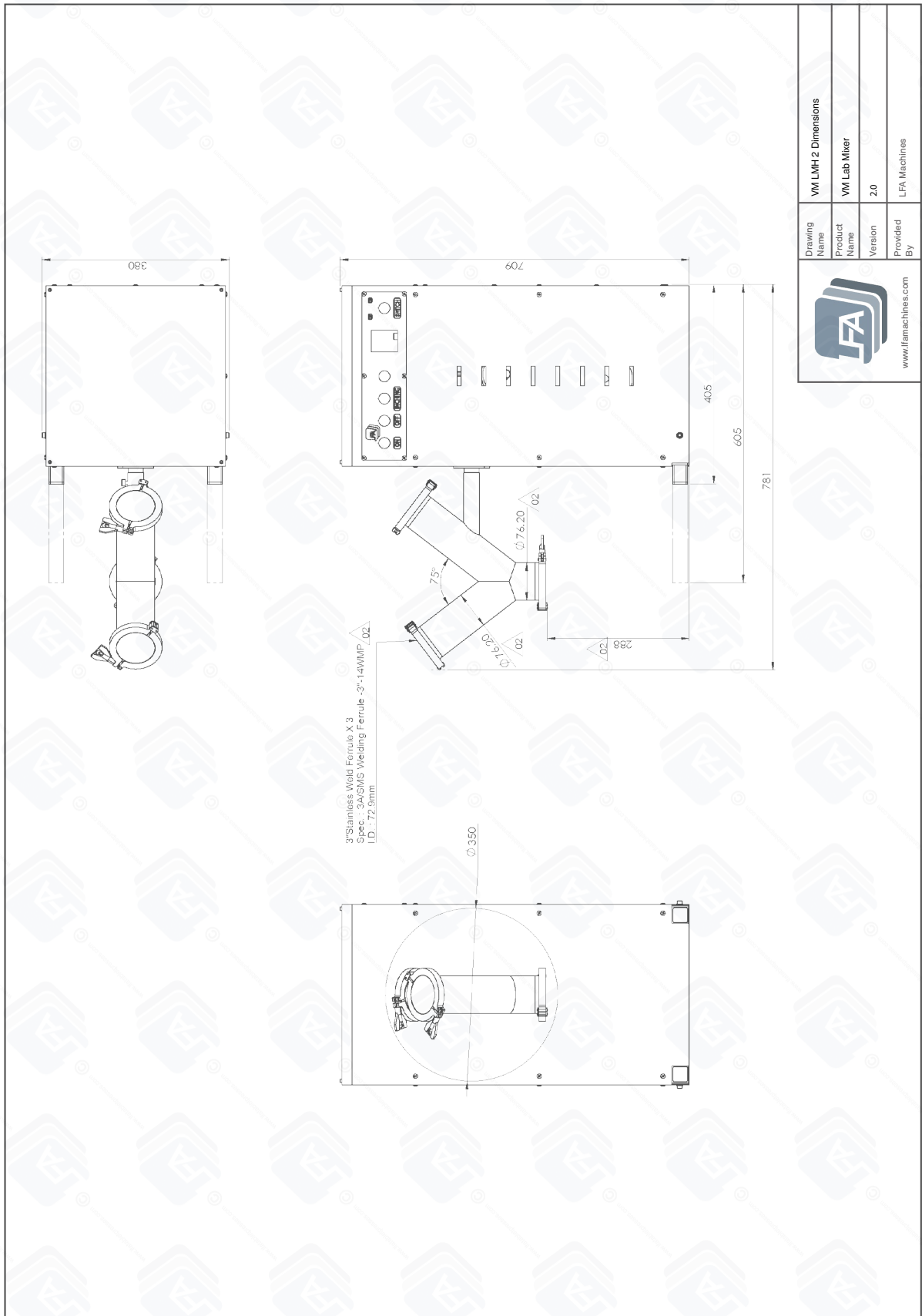

VM® LMH 15 Dimensions

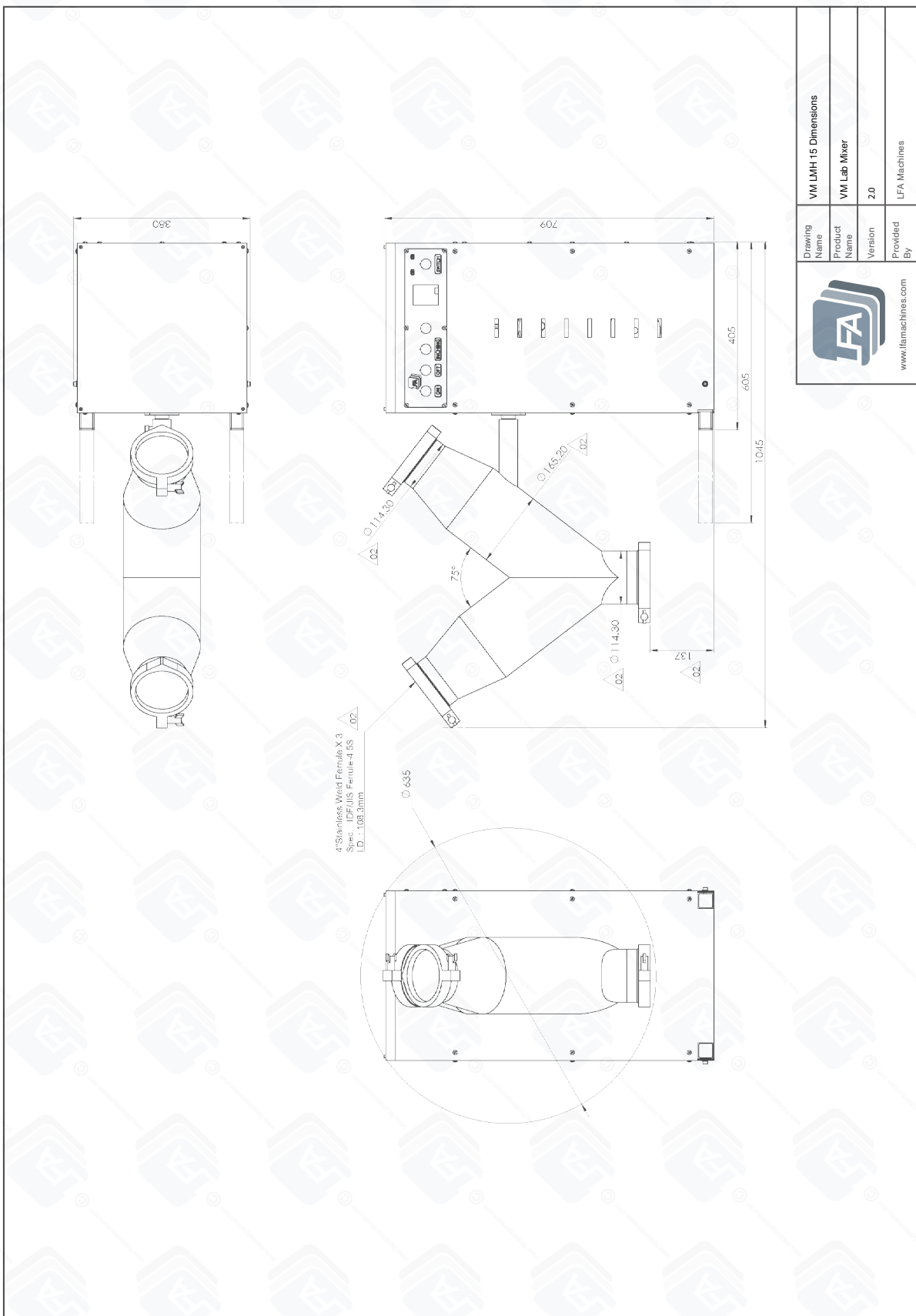

Drawing Name	VM LMH 15 Dimensions
Product Name	VM Lab Mixer
Version	2.0
Provided By	LFA Machines

www.lfamachines.com

Resources

Helpful Links

Warranty

For information regarding the warranty policy of the VM[®] Lab Mixer and other LFA products, please visit <https://www.lfatabletpresses.com/warranty>

LFA Website

In order to aid you in your powder mixing, LFA Machines maintains a website that offers a breadth of useful information about the VM[®] Lab Mixer and other powder mixers. You can watch videos or read our regularly published articles that cover a whole range of topics about powder mixing and tablet/capsule production.

Visit the LFA homepage at <https://www.lfatabletpresses.com/>

LFA Machines YouTube Channel

Our YouTube videos provide you an opportunity to see demonstrations of how to use our mixers, common troubleshooting tips, and other LFA products such as capsule fillers and tablet presses. We regularly upload videos to give you a visual aid that will hopefully support you in your powder mixing efforts. To watch our videos, visit <https://www.youtube.com/channel/UCwtbcwja77ai7vX2o34FUkQ>

LFA Machines Social Media

Social media is a great way to keep yourself updated on new developments and exciting things happening at LFA Machines. The list below contains our current social media pages:

Twitter: @lfatabletpress

Instagram: @lfatabletpresses

Facebook: <https://www.facebook.com/lfatabletpresses>

LinkedIn: <https://www.linkedin.com/company/lfa-machines-oxford-ltd/>

Contact Us

UK

LFA Machines Oxford Ltd
Unit 4B Rowood Estate
Murdock Road
Bicester, Oxfordshire OX26 4PP
+44 01869 250234
support.uk@lfamachines.com
Monday-Friday
9AM-5PM GMT

USA

LFA Machines DFW, LLC
6601 Will Rogers Blvd
Fort Worth, TX 76140
+1 (682) 312 0034
support.usa@lfamachines.com
Monday-Friday
8AM-6PM UTC (Central)

Germany

LFA Machines Düsseldorf GmbH
Business Parc Am Trippelsberg 92
Düsseldorf, North-Rhine
Westphalia 40589
+41 21188250223
verkauf@lfamachines.com

Taiwan

LFA Machines Taiwan Ltd
7F-5, No. 2, Sec. 2 Taiwan Blvd
West District, Taichung City 403
Taiwan
+886 422031790
support.asia@lfamachines.com
Monday-Friday
9AM-5PM GMT+8



LFA MACHINES

Copyright © 2026 by LFA Machines

www.lfamachines.com

United Kingdom

Unit 4B
Murdock Road
Bicester
Oxfordshire
United Kingdom
OX26 4PP

United States

6601 Will Rogers Blvd
Fort Worth
Texas
United States
76140

Germany

Business Parc Am
Trippelsberg 92
Düsseldorf
Germany
40589

Taiwan

7F.-5, No. 2, Sec. 2
Taiwan Blvd., West Dist.,
Taichung City 403,
Taiwan