



DTP 25[®] Tablet Press User Manual



We don't just sell machines—
we provide service.

Copyright Notice

© LFA Machines Oxford Limited, published in 2026 by LFA Machines Oxford Limited 2026. Registered in England and Wales, company number 08428898, registered office for service Demar House 14 Church Road East Wittering, Chichester, West Sussex, PO20 8PS.

All rights reserved. No part of this publication may be reproduced or transmitted, in any form or by any means, or stored in any retrieval system of any nature, without prior permission, except for fair dealing under the Copyright, Designs and Patents Act 1988, or in accordance with the terms of license issued by the Copyright Licensing Agency in respect of photocopying and/or reprographic reproduction. Application for permission for other use of the copyright material including permission to reproduce extracts in other published works shall be made to the publisher. Full acknowledgment of author, publisher and source must be given.

All trade marks are acknowledged and are owned by their respective owners.

Important Safety Information

READ THIS BEFORE OPERATING MACHINE

Intended Use

The intended use of this machine is to press dry raw materials into tablet form.

Potential misuse of this machine includes:

- Applying too much force to the powder.
- Trying to fill the Die with powder by hand.
- Inserting Tooling that is too big for the machine.
- Not properly mounting the machine.
- Using powders that could explode under pressure.
- Using wet or damp material.

Personal Protection

For personal protection while transporting the DTP 25[®], abide by these actions:

- Use an engine hoist to lift the machine.
- Wear steel toe boots to prevent foot injury.
- Wear heavy duty grip gloves to ensure firm grasp on machine.
- Wear back support belt to prevent injury if needed.

For personal protection while operating the DTP 25[®], abide by these actions:

- Avoid wearing loose jewelry to prevent machine entanglement.
- Contain long hair to prevent machine entanglement.
- Wear safety goggles.
- Wear disposable latex/rubber gloves.
- Wear a hairnet (food grade products only).
- Wear a beard net if needed (food grade products only).

General Hazards

- Be aware of risk of entanglement and pinch point due to moving parts.
- Do not operate in a wet environment or with wet hands due to risk of electrical shock or burn.
- Do not operate if any wires are damaged, pinched, or frayed due to risk of electrical shock or burn.
- Keep out of reach of children.
- Keep fingers away from all moving parts.
- Ensure that it is secured to a workbench to prevent from falling.
- Inspect machine before use.
- Check that nuts and bolts are suitably tightened.
- Use this machine only for its intended use as described in this manual.
- Turn off and unplug the machine before conducting cleaning and maintenance.
- Do not modify the machine in any way.
- Turn off and unplug the machine before conducting cleaning and maintenance.

Safety Assessment

It is critical to conduct a safety assessment to ensure that it complies with all local laws and industry accepted safety regulations.

If you require guidance on the installation of the machine or conducting a safety assessment, please contact LFA Machines.

Important Safety Information

READ THIS BEFORE OPERATING MACHINE

Symbols



WARNING

This signals potential risk for personal injury.



WARNING

This signals potential risk for electrical shock.



CAUTION

This signals potential risk for damage to the machine or other parts.

Modes for Stopping

In the case of an emergency during manual operation, immediately stop turning the Hand Wheel and remove yourself from the DTP 25[®].

In the case of an emergency during motor operation, immediately turn the Emergency Stop button and unplug.



Prop. 65 Statement for CA Residents

Based on LFA's current level of knowledge of our machines, the DTP 25[®] does not require a Proposition 65 warning label.

Warning for Explosive Material

This machine is not explosion proof. LFA recommends that you test your materials' explosivity before running them through this machine. If your materials are indeed explosive, do not use them with this machine.

Table of Contents

Copyright Notice	2
Important Safety Information	3
Intended Use	3
Personal Protection	3
General Hazards	3
Safety Assessment	3
Symbols	4
Modes for Stopping	4
Prop. 65 Statement for CA Residents	4
Warning for Explosive Material	4
DTP 25[®] Parts List	7
Preface	8
Training	9
Off-Site Training	9
Training via Video Chat/Phone	9
LFA Articles	9
LFA Videos	9
Installation	10
Tools and Materials Needed	10
The Appropriate Workstation for the Machine	10
Positioning the DTP 25 [®]	13
Manual and Electrical Controls	14
Settings and Adjustment	17
Maintenance	23
General Maintenance Prescriptions	23
Lubrication	23
Dismantling for Repair and Replacement	27
Wear Parts and Causes of Damage	27
Tooling	28
Boot	32
Boot Teflon Pads	35
Boot Timing Bar Runner Bolt	39
Perspex Door	43
Troubleshooting	45
Common Machine/Part Issues	45
Common Tablet Issues	47
De-Jamming the DTP 25 [®]	48
Cleaning	50
Storing the DTP 25 [®]	55
Appendix	57
Glossary	57
Description of DTP 25 [®] Parts	58
Material of Contact Parts	63
Technical Specifications	63
Maintenance Checklist	64
Diagrams	65
Resources	69

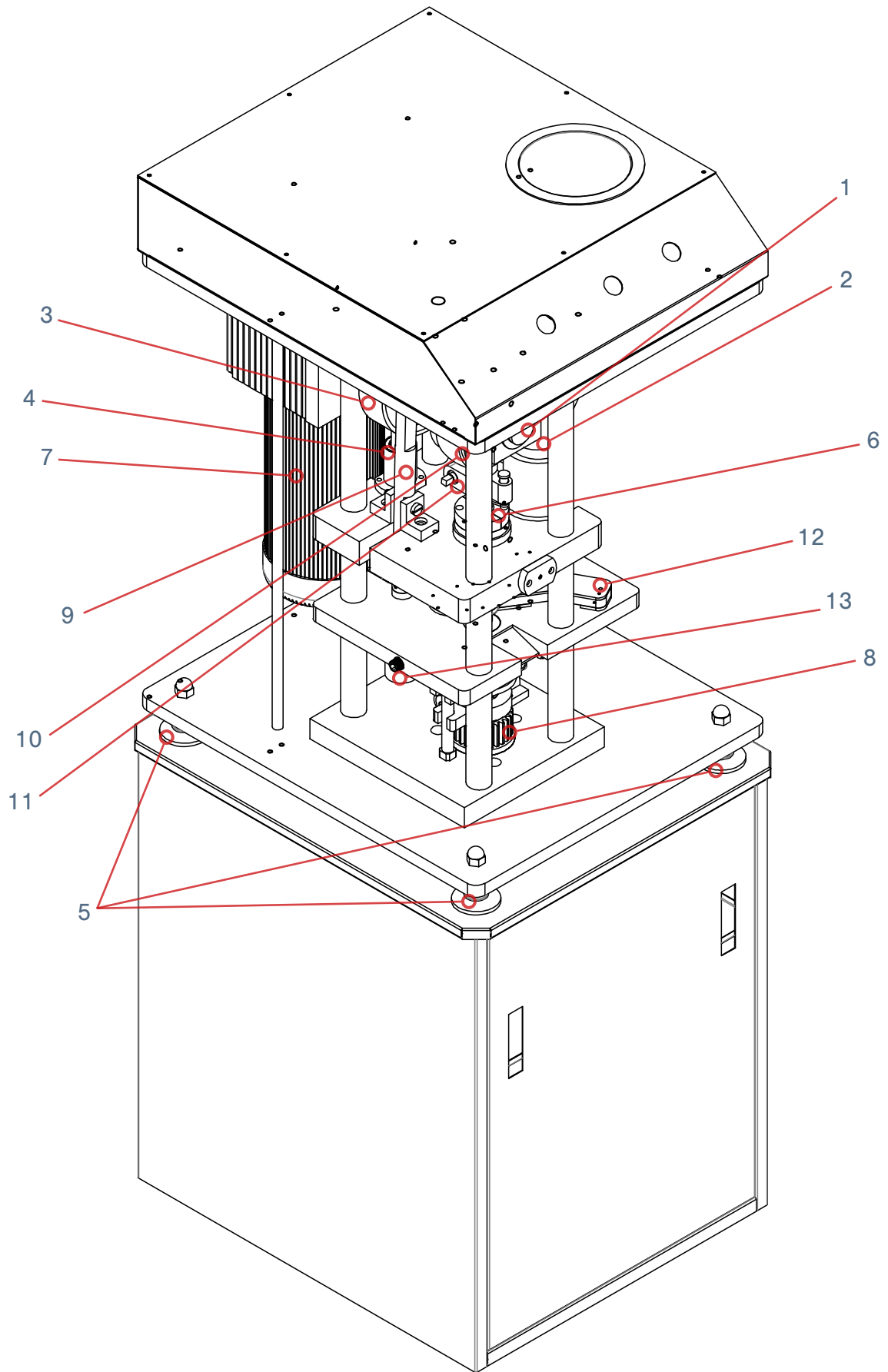

DTP 25[®] Parts List

- 1. Top Cam**
- 2. Hopper**
- 3. Boot Timing Cam**
- 4. Lower Drift Pin Assembly Timing Rod**
- 5. Anti-Vibration Feet**
- 6. Upper Drift Pin Assembly**
- 7. Motor**
- 8. Lower Drift Pin Assembly Cog**
- 9. Boot Timing Bar**
- 10. Eccentric Sheave**
- 11. Eccentric Sheave Strap**
- 12. Boot**
- 13. Lower Drift Pin Assembly Lifting Bar**

Preface



The DTP 25[®] is an advanced, single-headed press that makes tablet compression fast, easy, efficient, and safe. This compact machine is lightweight but able to exert 50 kN of pressure to produce tablets up to 25 mm in diameter. With its features of protective casing, electronic control panel, and advanced feeder mechanism, the DTP 25[®] provides safety for operators, simple adjustments of parameters, and a maximum production of 3,600 tablets per hour. Ideal for use in the pharmaceutical, chemical, electronic, foodstuff, and other industries, this tablet press is a cost-effective solution for users seeking moderate quantities of tablet production with an emphasis on convenience and ease of use.

The purpose of this document is to support your understanding of the DTP 25[®]'s components, features, functions, and design. With this manual, you will be able to successfully operate and maintain your DTP 25[®] machine.

The user manual's content includes:

- Important safety information
- DTP 25[®] installation instructions
- Description of the DTP 25[®]'s operation
- DTP 25[®] maintenance information
- Appendix with supplemental information

Training

DTP 25[®] training is essential for the machine's successful operation and your personal safety. There are several methods to prepare you for working with the DTP 25[®].

Off-Site Training

LFA offers training at our UK, USA, and Taiwan facilities for all our customers and their teams. For more information, go to <https://www.lfatabletpresses.com/services>

Training via Video Chat/Phone

Using an online video chat system, an LFA technician can interact face-to-face with you and assist with your understanding of the machine. Or, if you prefer, LFA can provide training via phone for all customers who call the office. To set up a training, call or email your local LFA office:

UK

Phone

+44 (0) 0345 165 20 25

Email

sales@lfamachines.com

USA

Phone

(682) 312-0034

Email

sales.usa@lfamachines.com

Taiwan

Phone

+886 2773 74704

Email

sales.asia@lfamachines.com

LFA Articles

LFA writes informative articles about desktop tablet presses, which includes instructions, procedures, and guides. To access the articles, go to <https://www.lfatabletpresses.com/articles>

LFA Videos

LFA has created several videos involving the DTP 25[®] and other desktop tablet presses. To access the videos, go to <https://www.lfatabletpresses.com/videos> or <https://www.youtube.com/user/TabletPilPress>

Installation

Tools and Materials Needed

Before you install and operate the DTP 25[®], it is best to have the following tools and materials on hand for general operation and maintenance:

- Engine hoist or lift and lifting strap
- Hammer
- Rubber mallet
- Metric wrench set and adjustable wrench
- Circlip pliers
- Power drill
- Pliers/grippers
- Flathead screwdriver
- Crosshead screwdriver
- Set of metric Allen keys with ball ends
- Permanent marker
- Long wire pipe cleaner
- Lubricant (NSF approved for food grade products)
- Grease gun
- Toothbrush
- Bagless vacuum
- Cleaner (e.g. Member's Mark Commercial Lemon Disinfectant)
- Sanitizer (e.g. Member's Mark Commercial Sanitizer)
- Cleaning brush set
- Plastic sheet or something similar to cover machine
- Safety goggles
- Disposable latex/rubber gloves
- Hairnet and/or beard net (food grade products only)
- Sterile shoe covers (food grade products only)

The Appropriate Workstation for the Machine

Find a stable workspace surface that supports the DTP 25[®]'s 150 kg (about 330 lbs) weight, such as a wooden bench (use stainless steel if for food grade industry). Another important thing to consider is to find a bench that has a suitable working height for you. This machine also has a single phase 220 V ($\pm 10\%$) electrical requirement, so ensure that it is near an appropriate power plug.

Environmental Conditions

It is important that the environment in which you operate and store the DTP 25[®] has the appropriate temperature and relative humidity levels. These two environmental factors can potentially cause the machine to rust and/or cause the tablets to have a lower quality. The table below shows the acceptable temperature and relative humidity levels:

Machine	Temperature		Humidity
DTP 25 [®]	°C	°F	45-65% RH
	18-24	64-75	

The shipping crate will contain the following:

1. The assembled DTP 25[®]

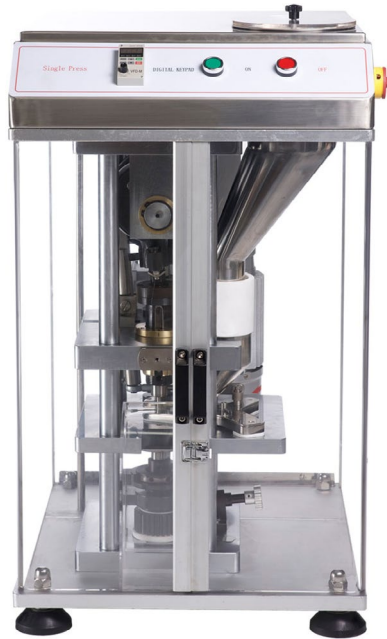

2. The Tooling (already installed)



Unpacking the DTP 25®

Tools Needed

- Crowbar
- Hammer

Instructions

1. Pry open each of the shipping container's paneling at the bottom with a crowbar and hammer to loosen it from the base.



2. Pry off the wooden panels from around the base with a crowbar and hammer.



Positioning the DTP 25[®]

WARNING: To prevent personal injury, wear steel toe boots and heavy duty grip gloves while transporting the DTP 25[®].



LFA does NOT recommend carrying the machine manually but rather with an engine hoist. At least two people should be involved (one operating the engine hoist and one stabilizing the machine) in removing the machine from the shipping container and placing it in the workspace.

Transporting the DTP 25[®]

Tools and Materials Needed

- Engine hoist and lifting strap

Instructions

1. Wrap the lifting strap around the top and bottom of the Perspex Casing.
 - 1.1 Note: The photo below is of a smaller DTP model.



2. Attach the lifting strap to the engine hoist and carefully guide the DTP 25[®] to the desired workspace.

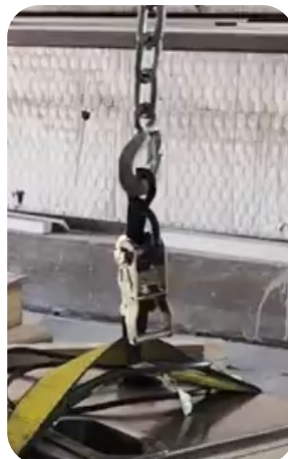

Manual and Electrical Controls

Basic Components

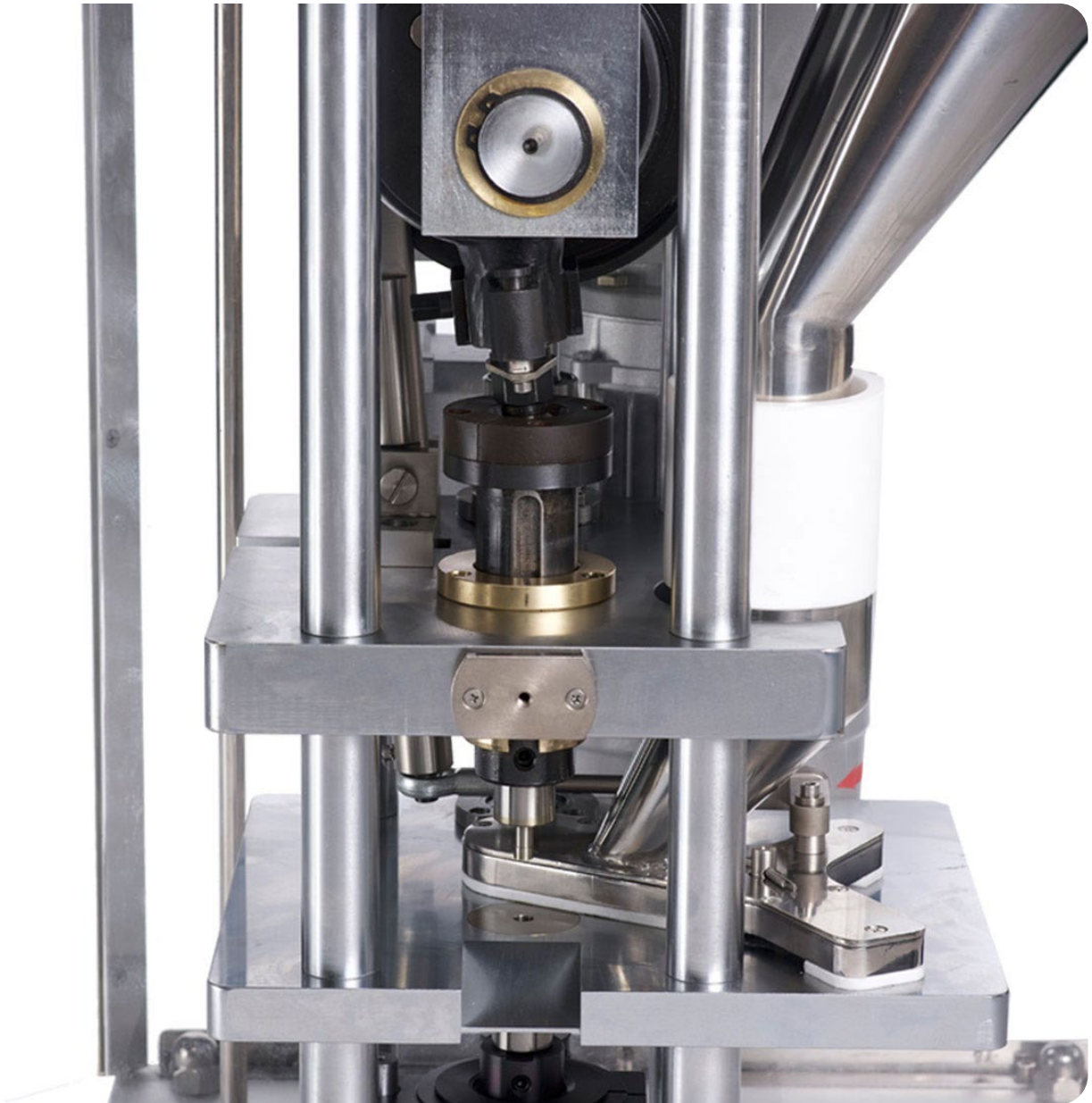

A description of the principal components follows:

- The **Top Cam** guides the punches' movement.
- The **Hopper** holds the dry materials that will be compressed.
- The **Boot** moves the materials from the Hopper to the Tooling and ejects the tablets.
- The **Die** defines or molds the size and shape of the powder.
- The **Upper Punch** and **Lower Punch** compress the materials within the Die.

DTP 25[®] Process

The basic mechanism of the DTP 25[®] involves filling the Tooling (Die, Upper Punch, and Lower Punch) with powder, compressing the powder, and ejecting the tablet.

Filling the Tooling with Powder

The dry materials are poured into the Hopper, which funnels the powder into the Boot. As the Hand Wheel is manually operated, the Top Cam withdraws the Upper Punch from the Die.

When the machine is operated by the motor, the Gearbox initiates the movement of the Top Cam, which withdraws the Upper Punch from the Die.

Compressing the Powder

After the powder is filled in the Tooling, the Top Cam drives the Upper Punch into the Die and the Lower Punch. Both punches then come together to compress the powder under high pressure.

Ejecting the Tablet

After both punches compress the powder into a tablet, the Top Cam withdraws the Upper Punch while the Lower Punch is pushed upward to expel the tablet. The tablet is then pushed out of the way by the Boot to prepare for the next tablet compression.

How to Create Tablets with the DTP 25®

Tools and Materials Needed

- Raw material formulation
- DTP 25®
- Safety goggles
- Disposable latex/rubber gloves (for food grade products and to protect hands from grease)
- Hairnet and/or beard net (food grade products only)
- Sterile shoe covers (food grade products only)



WARNING: For personal protection while operating the DTP 25®, contain long hair and do not wear loose jewelry.

Instructions

Note: Wear latex/rubber gloves (and appropriate food grade attire if applicable) during this process.

1. Remove the Hopper's lid from the top of the machine.
2. Pour the dry materials into the Hopper.
 - 2.1 Note: Ensure that the DTP 25® is unplugged from the electrical outlet.
3. Open the Perspex Doors and rotate the Hand Wheel in the direction indicated by the arrow located on the Motor.
 - 3.1 Note: Always manually operate the DTP 25® for one rotation before running the machine.



4. Plug in the DTP 25® to an electrical outlet.
5. Press the green button (ON) to start operation and the red button (OFF) to stop.



Settings and Adjustment

The DTP 25[®]'s settings can be adjusted. Tuning the Tooling and adjusting the motor speed can help with changing the tablets' characteristics and how they are ejected from the machine.

Ejection Height

When the Upper Punch is fully lifted, the Lower Punch in its highest position should be flush with the Die:

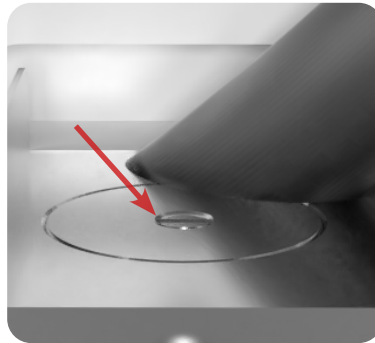

If the Lower Punch is above or below the Die's face, it will affect how smoothly the tablet is ejected. Adjusting the ejection height will help with this and can vary with different forms of Tooling.

Tools and Materials Needed

- Set of metric Allen keys with ball ends
- Adjustable wrench
- Disposable latex/rubber gloves (for food grade products and to protect hands from grease)
- Hairnet and/or beard net (food grade products only)
- Sterile shoe covers (food grade products only)



WARNING: To prevent any potential personal injury, unplug the DTP 25[®] from the electrical outlet

Instructions

Note: Wear latex/rubber gloves (and appropriate food grade attire if applicable) during this process.

1. Produce a test tablet to determine how the Tooling should be adjusted.
2. Open the Perspex Doors and remove the tablet collector.

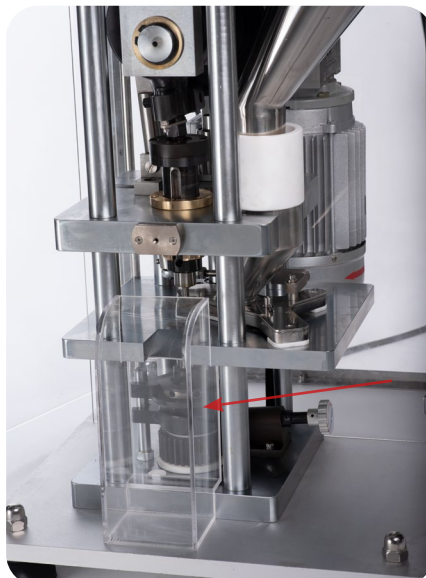

3. Rotate the machine until the Lower Drift Pin Assembly is at its highest position and the Boot is at the position to eject the tablet.
4. Loosen the ejection height adjustment locking screw with an adjustable wrench.
5. Insert an Allen key into one of the ejection height adjustment's holes and turn to adjust.
 - 5.1 Note: Turn clockwise to raise the ejection height. Turn counterclockwise to lower ejection height.

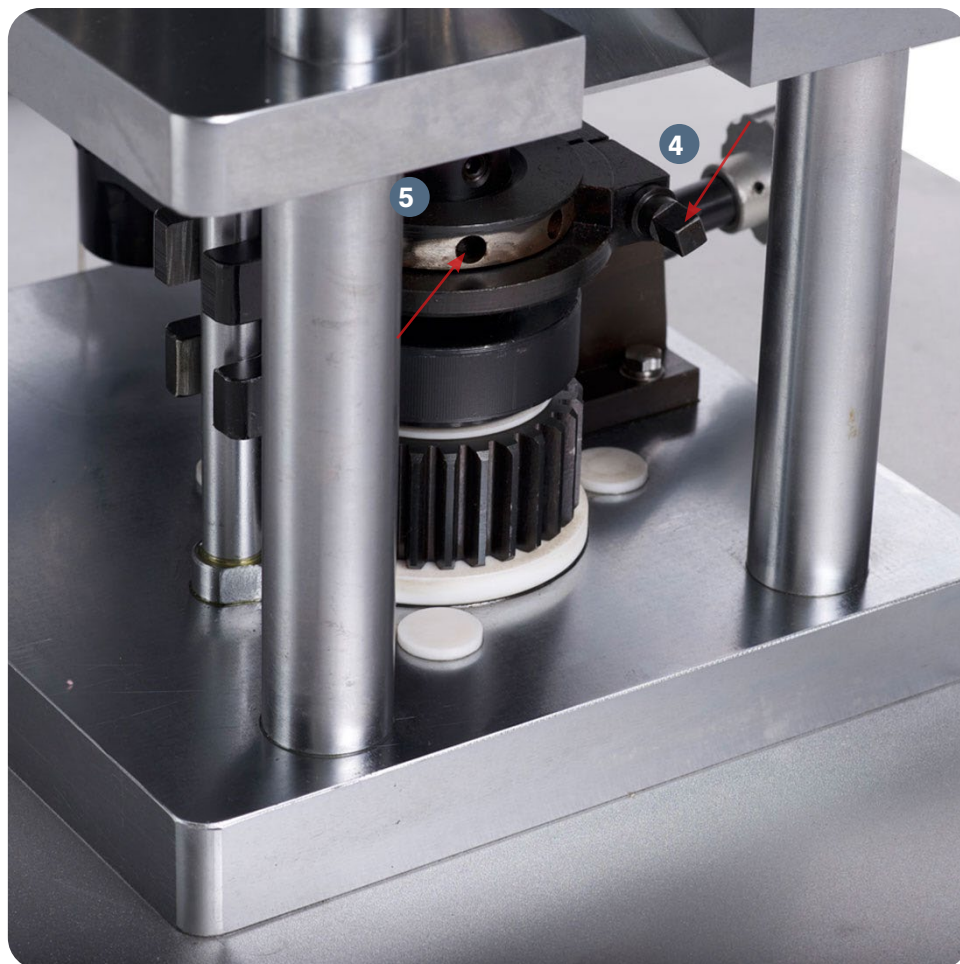

6. Tighten the ejection height adjustment locking screw with an adjustable wrench.
7. Place back the tablet collector and close the Perspex Doors.

Fill Depth

At times, a tablet will be too small or too large, and its weight must change. Adjusting the fill depth determines the tablet's thickness and weight. This can be controlled by changing how high or low the Lower Punch sits.

Tools and Materials Needed

- Disposable latex/rubber gloves (for food grade products and to protect hands from grease)
- Hairnet and/or beard net (food grade products only)
- Sterile shoe covers (food grade products only)



WARNING: To prevent any potential personal injury, unplug the DTP 25® from the electrical outlet.

Instructions

Note: Wear latex/rubber gloves (and appropriate food grade attire if applicable) during this process.

1. Open the Perspex Doors and produce a test tablet to determine how the Tooling should be adjusted.
2. Pull the locking handle on the fill depth adjustment away from the machine to loosen it.
3. Rotate the fill depth adjustment wheel to change the tablet's weight.
 - 3.1 Note: To increase the tablet weight, turn clockwise. To decrease the tablet weight, turn counterclockwise.

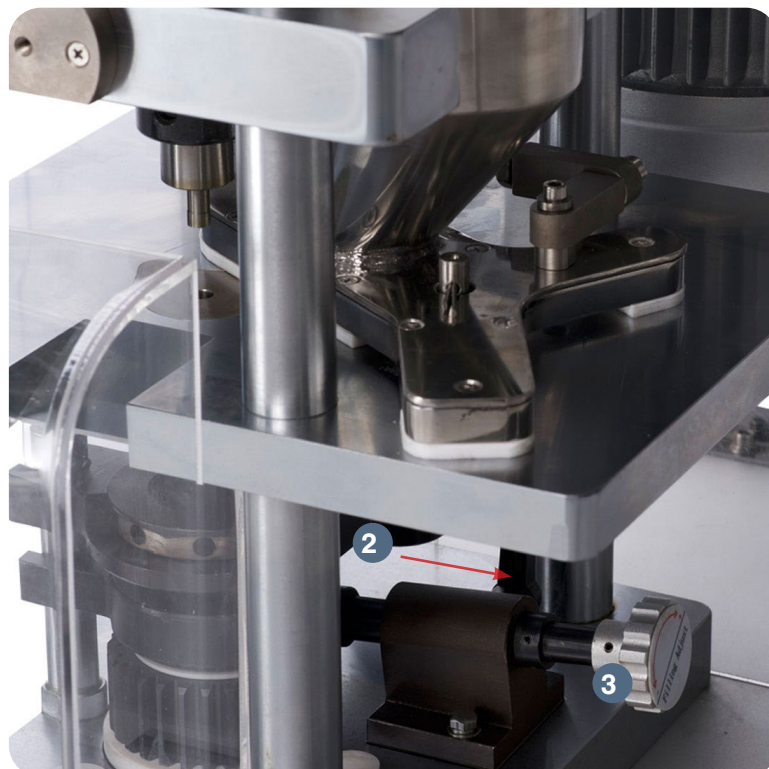

4. Push back the fill depth adjustment's locking handle to tighten it.
5. Close the Perspex Doors.

Motor Speed

The DTP 25®'s control console has a variable frequency drive (VFD) that can adjust the DTP 25®'s motor speed, which affects how quickly the machine operates and therefore tablet production speed.

Tools and Materials Needed

- Disposable latex/rubber gloves (for food grade products and to protect hands from grease)
- Hairnet and/or beard net (food grade products only)
- Sterile shoe covers (food grade products only)

Instructions

Note: Wear latex/rubber gloves (and appropriate food grade attire if applicable) during this process.

1. Produce test tablets to determine how the motor speed should be adjusted.
2. Turn the dial on the VFD to adjust the production speed.
 - 2.1 Note: Rotate the dial clockwise to increase the production speed. Rotate the dial counterclockwise to decrease the production speed.



Punch Pressure

Sometimes tablets come out too soft and will crumble easily, which happens often after increasing the fill depth. Or, the machine can jam and will not be able to turn over. To correct this, the punch pressure needs to be adjusted in order to increase the tablet's firmness/de-jam the machine.

Tools and Materials Needed

- Adjustable wrench
- Disposable latex/rubber gloves (for food grade products and to protect hands from grease)
- Hairnet and/or beard net (food grade products only)
- Sterile shoe covers (food grade products only)



WARNING: To prevent any potential personal injury, unplug the DTP 25[®] from the electrical outlet.

CAUTION: Overtightening can damage the Tooling and/or Boot.

Instructions

Note: Wear latex/rubber gloves (and appropriate food grade attire if applicable) during this process.

1. Open the Perspex Doors and produce a test tablet to determine how the Tooling should be adjusted.



2. Remove the punch pressure adjustment's locking screw with an adjustable wrench.
3. Rotate the Upper Drift Pin Assembly to change the punch pressure.
 - 3.1 Note: Rotate the Upper Drift Pin Assembly clockwise to increase the pressure. Rotate the Upper Drift Pin Assembly counterclockwise to decrease the pressure.



4. Reinsert the punch pressure adjustment's locking screw and tighten it with an adjustable wrench.
5. Close the Perspex Doors.

Maintenance

To ensure that the DTP 25[®] will have a long operational life, maintenance is essential. This section includes methods for replacing parts, troubleshooting solutions, and how often to grease and clean your machines to keep its performance optimal.

General Maintenance Prescriptions

- Use the maintenance checklist (found in the Appendix) before, during, and after machine operation.
- Make sure all grease points are maintained and regularly lubricated.
- Use an appropriate amount of lubricant. Excess grease can drip into the tablets as they are formed.
- Before reassembling the machine after cleaning, make sure that the parts are dried and oiled.
- Constantly check for any loose nuts and/or screws before, during, and after machine operation.
- If the machine is not used for more than a week, place the Tooling in an airtight container and cover in lubricant.

Lubrication

Regularly greasing your machine is vital to prolonging its operational life. Parts that are not greased properly can make the machine seize up and cause major problems later. LFA recommends maintaining a lubrication schedule for your DTP 25[®], which can be found in this section.

Tools and Materials Needed

- Crosshead screwdriver
- Lubricant/grease (food grade if machine has contact with the food or drug product)
- Set of metric Allen keys with ball ends
- Disposable latex/rubber gloves (for food grade products and to protect hands from grease)
- Hairnet and/or beard net (food grade products only)
- Sterile shoe covers (food grade products only)



WARNING: To prevent any potential personal injury, unplug the DTP 25[®] from the electrical outlet.

Instructions (continued on next page)

Note: Wear latex/rubber gloves (and appropriate food grade attire if applicable) during this process.

1. Rub a finger's worth of grease on the Boot Timing Cam's sides.
 - 1.1 Note: Be sure to lubricate the Boot Timing Cam runner and the Lower Drift Pin Assembly Timing Rod runner.



2. Remove the Upper Drift Pin Assembly's lock with a crosshead screwdriver..
3. Lubricate the end of the lock at the point where it meets directly with the Upper Drift Pin Assembly.

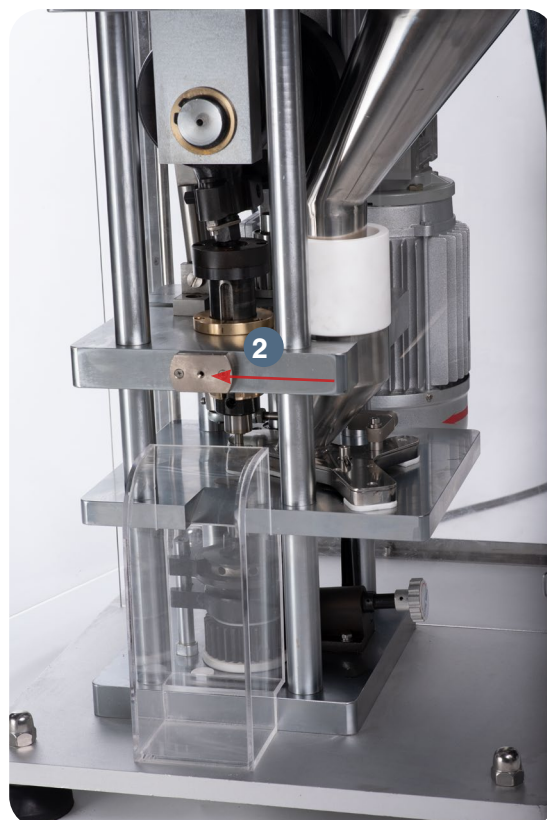

4. Apply grease to the Upper Drift Pin Assembly.



Lubrication Schedule

LFA recommends the following DTP 25® parts to be lubricated according to the following frequency:

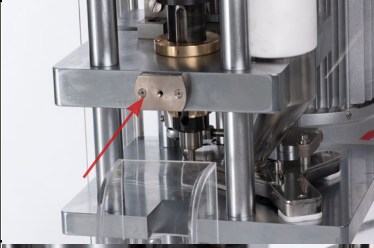
Part	Location	Image	Frequency	Type of Lubricant
Tooling heads	The heads of the Upper Punch and Lower Punch		Visually inspect and apply when dry	Assembly Paste
Tooling (after cleaning)	Airtight storage container		Apply after cleaning	Mineral Oil
Gearbox	On top of the Motor		Visually inspect every week and top off when needed	460 Grade Worm Gear Oil
Upper Drift Pin Assembly	Remove the part from the press and lubricate the end that goes into the Upper Drift Pin Assembly's channel.		Apply in the following situations: (a) after every 50,000 tablets, (b) after a deep clean, or (c) when the press has not been used for a prolonged period of time	NLGI Grade 2
Upper Drift Pin Assembly Threaded Cam	The grooves in which the Upper Drift Pin Assembly and Upper Drift Pin Assembly Threaded Cam meet		Apply in the following situations: (a) after every 50,000 tablets, (b) after a deep clean, or (c) when the press has not been used for a prolonged period of time	NLGI Grade 2
Boot Timing Cam	Cam tracks on both sides and runners on Lower Drift Pin Assembly Timing Rod and Boot Timing Bar		Apply in the following situations: (a) after every 50,000 tablets, (b) after a deep clean, or (c) when the press has not been used for a prolonged period of time	NLGI Grade 2

Dismantling for Repair and Replacement

Eventually due to wear and tear, some parts of the DTP 25[®] will need to be removed for repair and replacement. To prevent any delays in your tablet production, it is best practice to keep extra parts just in case.

To buy a DTP 25[®] part replacement, simply go to <https://www.lfatabletpresses.com/products/pill-press-machine-spare-parts/dtp-parts>

Warranty

To access LFA's warranty policy, go to <https://www.lfatabletpresses.com/warranty>
If your part is eligible for warranty, have your part's serial number on hand and please contact LFA:

UK
Phone
+44 (0) 0345 165 20 25
Email
sales@lfamachines.com

USA
Phone
(682) 312-0309
Email
sales.usa@lfamachines.com

Taiwan
Phone
+886 2773 74704
Email
sales.asia@lfamachines.com



WARNING: To prevent any potential personal injury, ALWAYS unplug the DTP 25[®] from the electrical outlet when replacing parts.

Wear Parts and Causes of Damage

Wear Part	Cause of Damage
Tooling	The Tooling can become chipped or broken. Lead times for a new set of Tooling can take as long as 6-8 weeks, so LFA recommends having a spare set or two.
Boot	The Boot is formed from a brass casting. This part can become trapped between the Die bore and the Upper Punch, which usually results from user error.
Boot Teflon Pads	On the bottom of the Boot there are three pads that are used to protect the Tooling and the Boot against the Die table. These pads are made from Teflon and are designed over time to wear to avoid damage to more expensive parts.
Upper Cam Bushing	The upper cam bushing is a brass wear part that is used to keep the upper cam from coming into direct contact with the base of the machine. This part will need to be replaced after around 500 - 1,000 hours depending on the product being pressed and the pressure being used.

Tooling

If you want to change the shape and diameter of the tablet, or if the Upper Punch, Lower Punch, and/or Die you currently have is damaged, it is necessary to change the Tooling.

To buy new Tooling from LFA, simply go to <https://www.lfatabletpresses.com/products/tablet-press-tooling>

Tools and Materials Needed

- Set of metric Allen keys with ball ends
- Disposable latex/rubber gloves (for food grade products and to protect hands from grease)
- Hairnet and/or beard net (food grade products only)
- Sterile shoe covers (food grade products only)



WARNING: To prevent any potential personal injury, ALWAYS unplug the DTP 25[®] from the electrical outlet when replacing parts.

Instructions

Note: Wear latex/rubber gloves (and appropriate food grade attire if applicable) during this process.

Remove the Tooling

1. Open the Perspex Doors and remove the tablet collector.
2. Remove the Hopper up through the top of the press and pull off the Hopper Extender from the Boot.

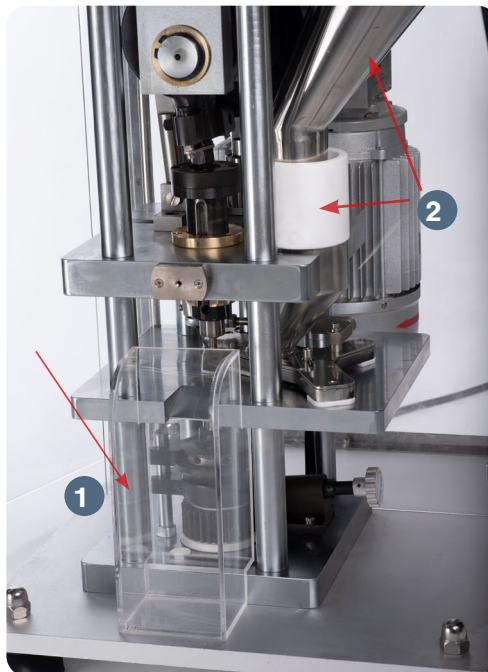

3. Remove the Boot Timing Bar Extender from the Boot with an Allen key.
4. Remove the pin from the Boot Bolt and Spring.



5. Move the Boot out of the way.

6. Loosen the Upper Punch's bolt with an Allen key and pull out the Upper Punch.



7. Loosen the Die's bolt with an Allen key.



8. Lift up the Die from the DTP 25[®] by hand.

8.1 Note: Lower the ejection height to assist with removing the Die. For further assistance, please refer to the ejection height adjustment instructions on page 17.

9. Loosen the Lower Punch's bolt with an Allen key and remove the Lower Punch.



Replace the Tooling

10. Insert the new Lower Punch into the Lower Drift Pin Assembly.
11. Reinsert the bolt that locks the Lower Punch with an Allen key.

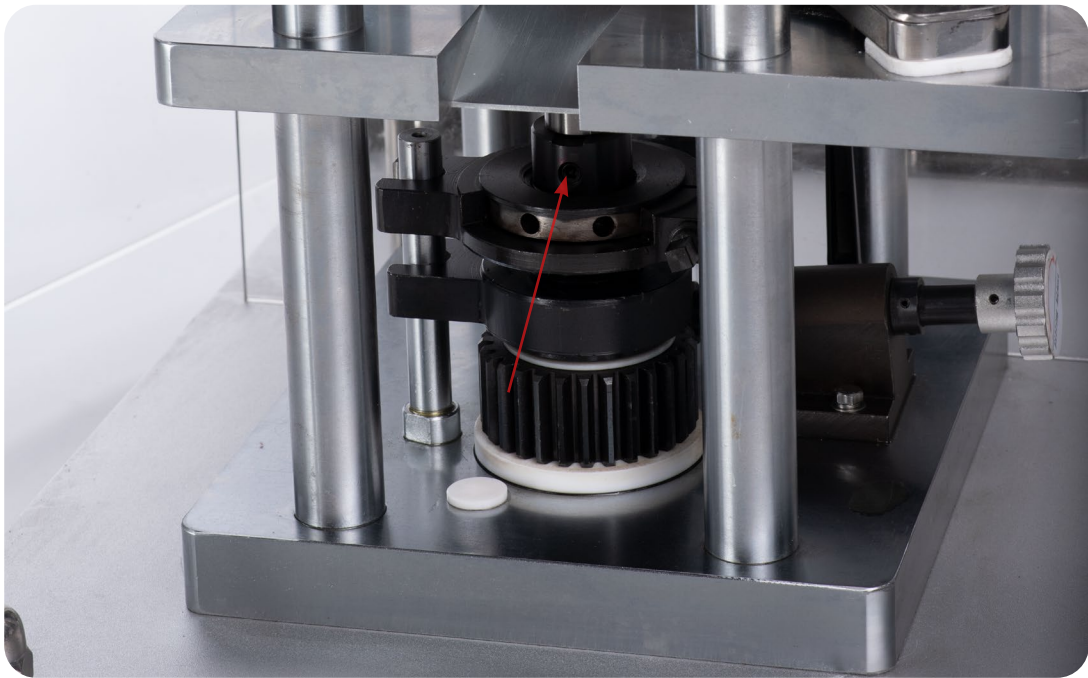

Note: To help ensure that the Die is inserted correctly, LFA recommends using an Insertion Ring. You can order the Die Seat Cleaner and Insertion Ring on our website at <https://www.lfatabletpresses.com/die-seat-cleaner-insertion-ring>



12. Insert the new Die into the middle of the DTP 25[®] and secure its bolt with an Allen key.
 - 12.1 Note: Make sure the set screw is not fully tightened.

13. Insert the new Upper Punch into the Upper Drift Pin Assembly.
14. Tighten the new Upper Punch's bolt with an Allen key.

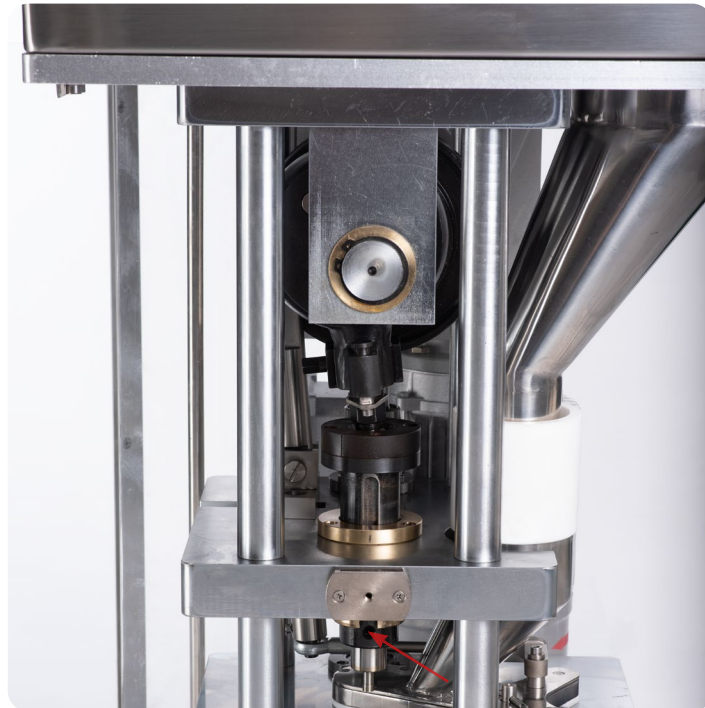

15. Rotate the Hand Wheel and carefully lower the Upper Punch into the Die.
 - 15.1 Note: To watch a video on proper Base Plate alignment, go to <https://www.fatablepresses.com/videos/how-to-align-a-baseplate-on-a-tdp-5>
16. Tighten the Base Plate's bolts with an Allen key.
17. Position the Boot back on the Base Plate.
18. Resecure the Boot Timing Bar extender to the Boot with an Allen key.
19. Resecure the Boot Bolt and Spring underneath the Boot with an Allen key.
20. Tighten the Boot's set screw with an Allen key.
21. Insert the Hopper into the Boot.
22. Close the Perspex Doors.

Boot

Due to its constant movement, the Boot can wear down and prevent granular material from flowing smoothly. Replacing this part is a simple process.

Tools and Materials Needed

- Set of metric Allen keys with ball ends
- New Boot part
- Disposable latex/rubber gloves (for food grade products and to protect hands from grease)
- Hairnet and/or beard net (food grade products only)
- Sterile shoe covers (food grade products only)



WARNING: To prevent any potential personal injury, ALWAYS unplug the DTP 25[®] from the electrical outlet when replacing parts.

Instructions

Note: Wear latex/rubber gloves (and appropriate food grade attire if applicable) during this process.

Remove the Boot

1. Open the Perspex Doors and remove the tablet collector.

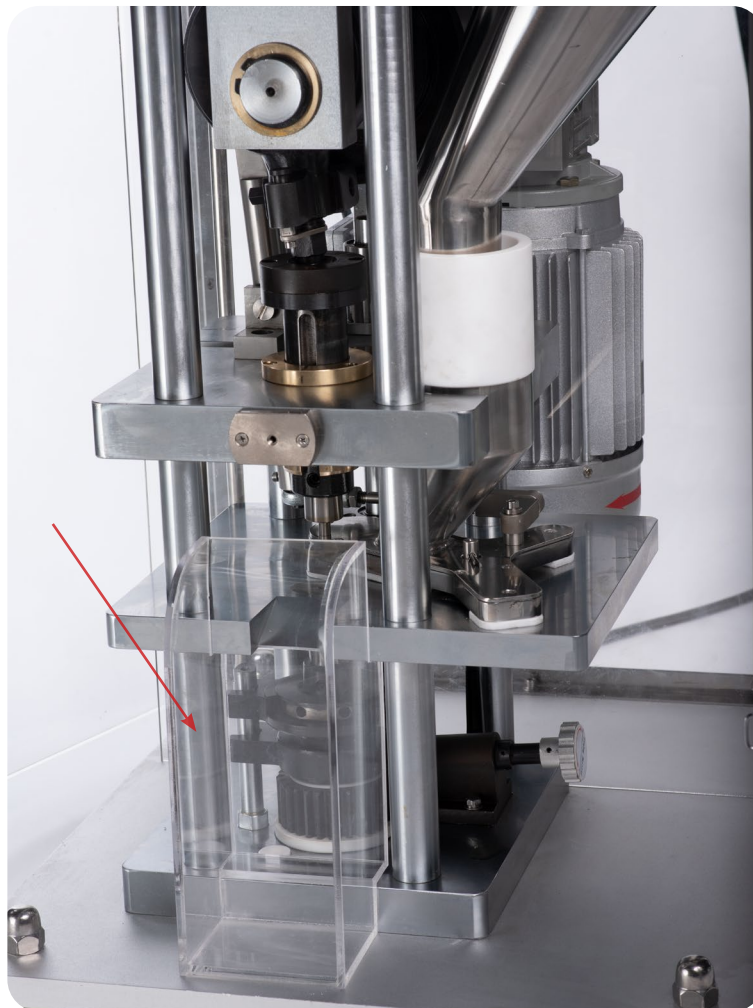

2. Remove the Hopper up through the top of the press and pull off the Hopper Extender from the Boot.

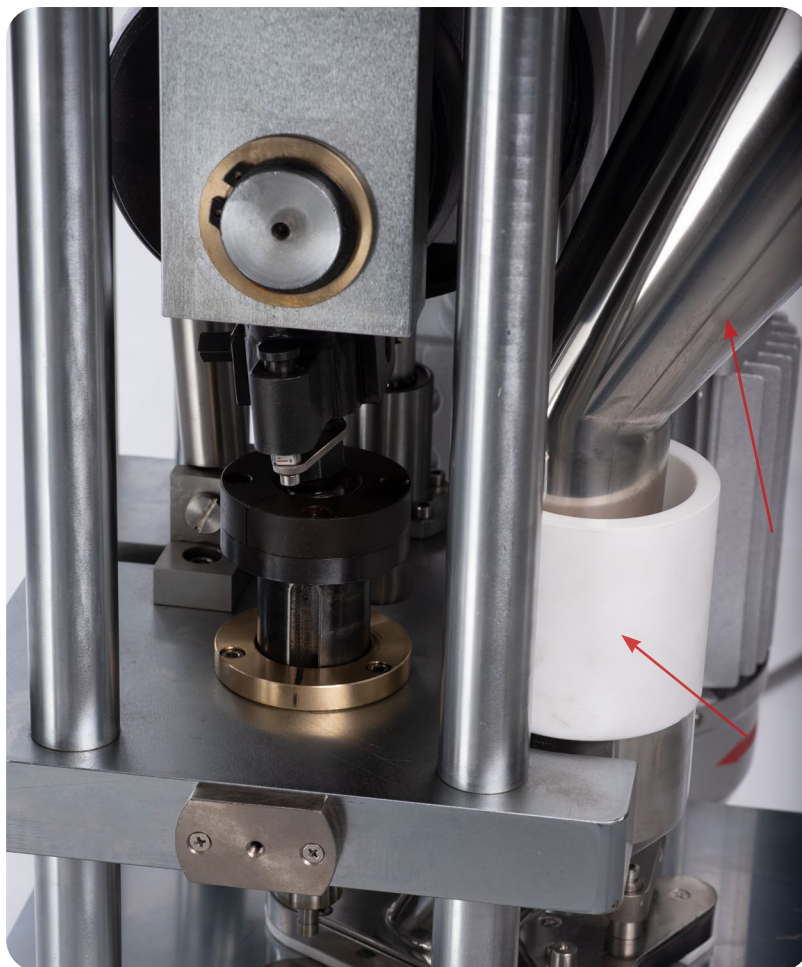

3. Remove the Boot Timing Bar Extender from the Boot with an Allen key.



4. Remove the pin from the Boot Bolt and Spring.

4.1 Note: The Boot Bolt and Spring will disengage from the Boot once its pin has been removed. Be careful to not let it fall.



5. Remove the Boot from the DTP 25®.

Replace the Boot

6. Align the new Boot with the Boot Bolt and Spring's insertion point.
7. Reinsert the Boot Bolt and Spring in the new Boot and reattach its pin.
8. Align the Boot Timing Bar Extender with the Boot and retighten its bolt with an Allen key.
9. Reinsert the Hopper Extender and Hopper into the new Boot.
10. Place back the tablet collector and close the Perspex Doors.

Boot Teflon Pads

The pads at the bottom of the Boot protect the Tooling and the Boot against the Die table. The Boot Teflon Pads are designed over time to wear to avoid damaging more expensive parts.

Tools and Materials Needed

- Set of metric Allen keys with ball ends
- Crosshead screwdriver
- New Boot Teflon Pads
- Disposable latex/rubber gloves (for food grade products and to protect hands from grease)
- Hairnet and/or beard net (food grade products only)
- Sterile shoe covers (food grade products only)



WARNING: To prevent any potential personal injury, ALWAYS unplug the DTP 25® from the electrical outlet when replacing parts.

Instructions

Note: Wear latex/rubber gloves (and appropriate food grade attire if applicable) during this process.

Remove the Boot Teflon Pads

1. Open the Perspex Doors and remove the tablet collector.

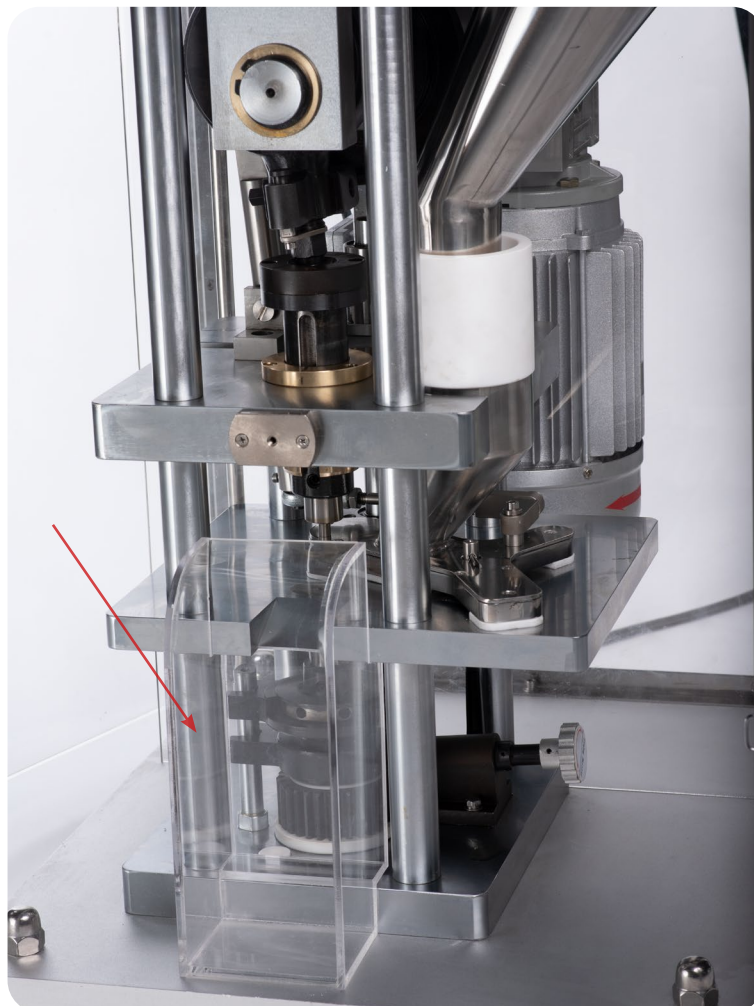

2. Remove the Hopper up through the top of the press and pull off the Hopper Extender from the Boot.

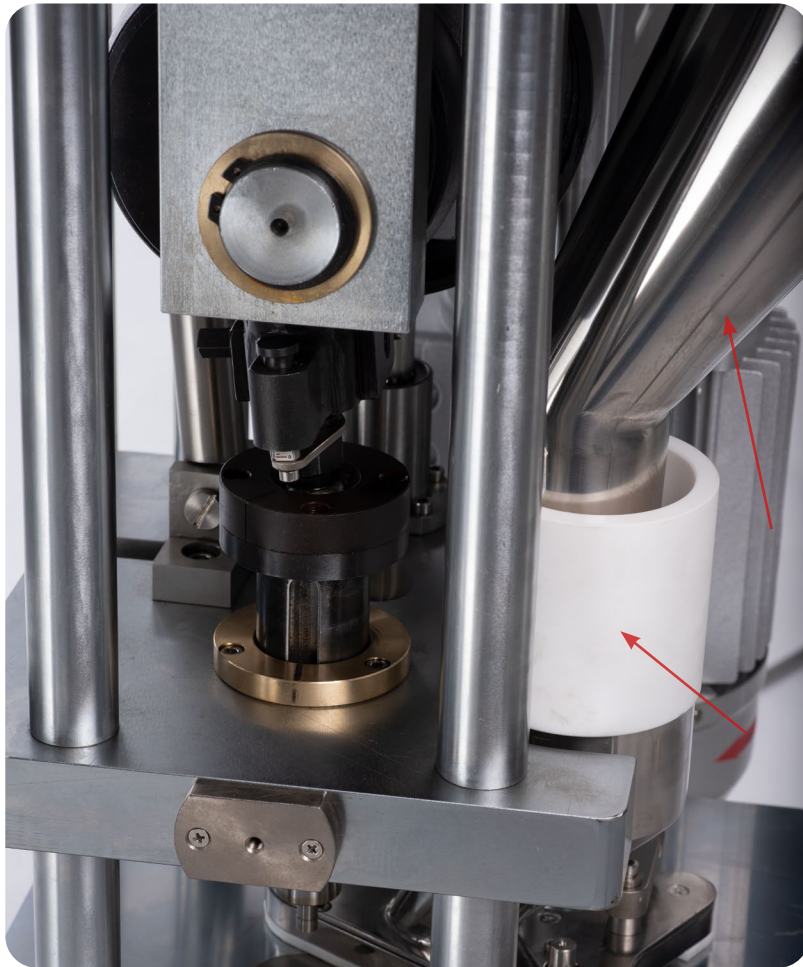

3. Remove the Boot Timing Bar Extender from the Boot with an Allen key.



4. Remove the pin from the Boot Bolt and Spring.

4.1 Note: The Boot Bolt and Spring will disengage from the Boot once its pin has been removed. Be careful to not let it fall.



5. Remove the Boot from the DTP 25®.

6. Remove each of the Boot Teflon Pads underneath with a crosshead screwdriver.

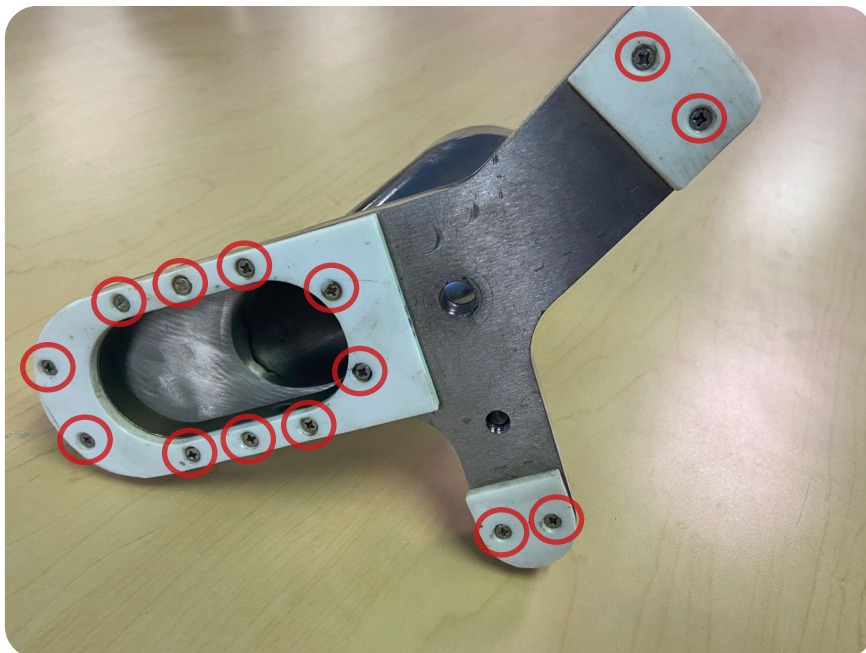

Replace the Boot Teflon Pads

7. Align one of the new Boot Teflon Pads against its screw holes in the bottom of the Boot.
8. Screw in the new Boot Teflon Pad with a crosshead screwdriver.
9. Repeat steps 7-8 until all the new Boot Teflon Pads are secured.
10. Align the Boot on with the Boot Bolt and Spring's insertion point.
11. Reinsert the Boot Bolt and Spring in the Boot and reattach its pin.
12. Align the Boot Timing Bar Extender with the Boot and retighten its bolt with an Allen key.



13. Reinsert the Hopper Extender and Hopper into the Boot.
14. Place back the tablet collector and close the Perspex Doors.

Boot Timing Bar Runner Bolt

The Boot Timing Bar Runner Bolt can be damaged due to overtightening and/or being under too much pressure.

Tools and Materials Needed

- Set of metric Allen keys with ball ends
- Phillips screwdriver
- Hammer
- New Boot Timing Bar Runner Bolt
- Disposable latex/rubber gloves (for food grade products and to protect hands from grease)
- Hairnet and/or beard net (food grade products only)
- Sterile shoe covers (food grade products only)



WARNING: To prevent any potential personal injury, ALWAYS unplug the DTP 25® from the electrical outlet when replacing parts.

Instructions

Note: Wear latex/rubber gloves (and appropriate food grade attire if applicable) during this process.

Remove the Boot Timing Bar Runner Bolt

1. Open the Perspex Doors and remove the tablet collector.



2. Remove the Boot Timing Bar Extender's pin with an Allen key.

2.1 Note: The Boot Timing Bar's pin will fall from the Boot Timing Bar.

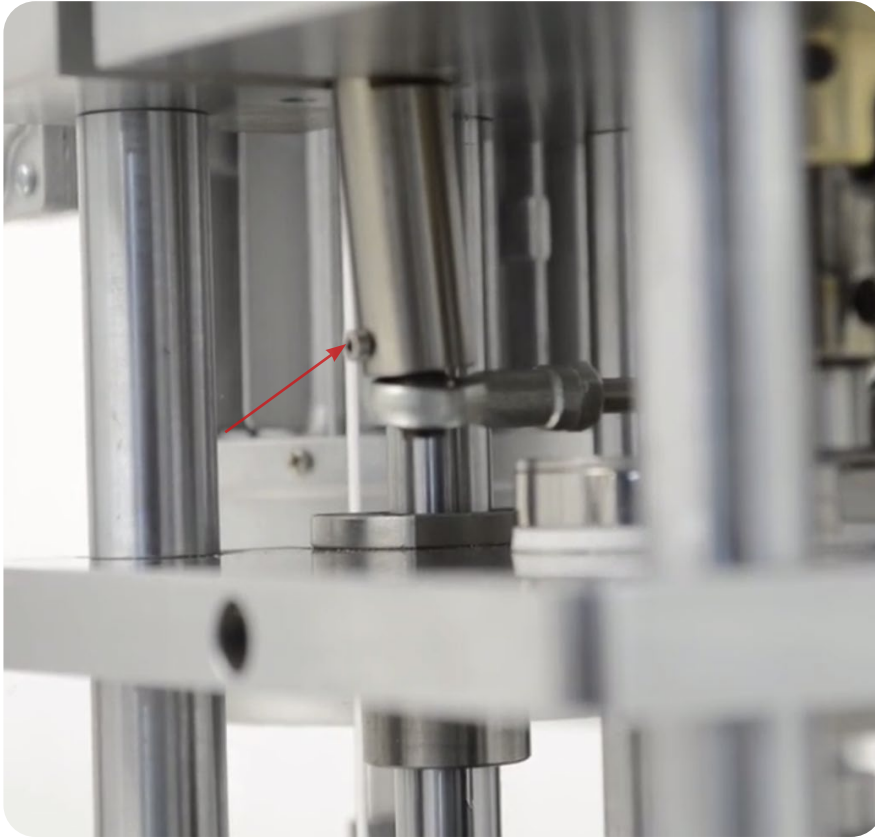

3. Remove the Boot Timing Bar's pin with a Phillips screwdriver/by hand.

3.1 Note: Ensure that the pin's washer and nut are also removed.

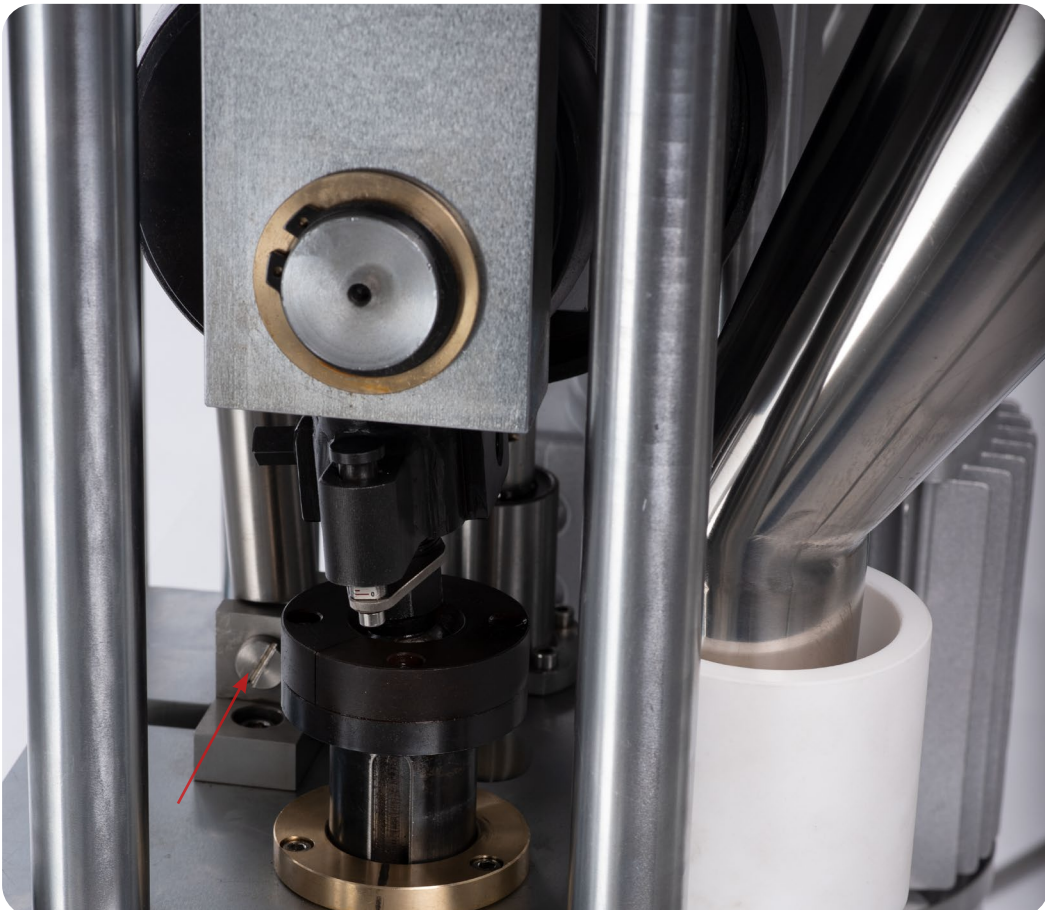

4. Remove the Boot Timing Bar's set screw with an Allen key.
5. Pull out the Boot Timing Bar from the Boot Timing Cam.- 5.1 Note: Manually rotate the press to move the Boot Timing Cam to a position in which the Boot Timing Bar's removal is easier.

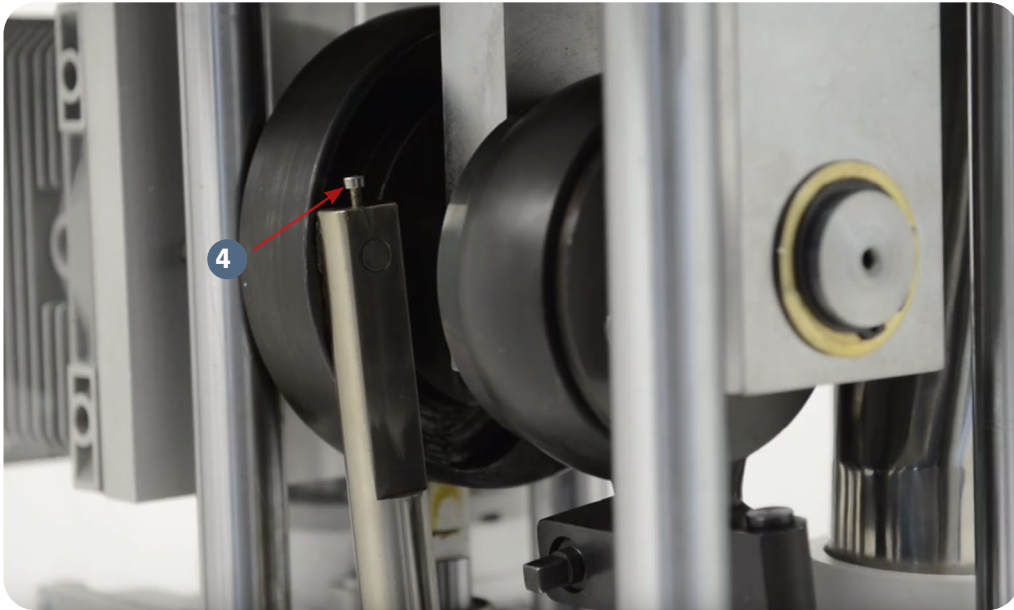

6. Hammer out the Boot Timing Bar Runner Bolt from the Boot Timing Bar.

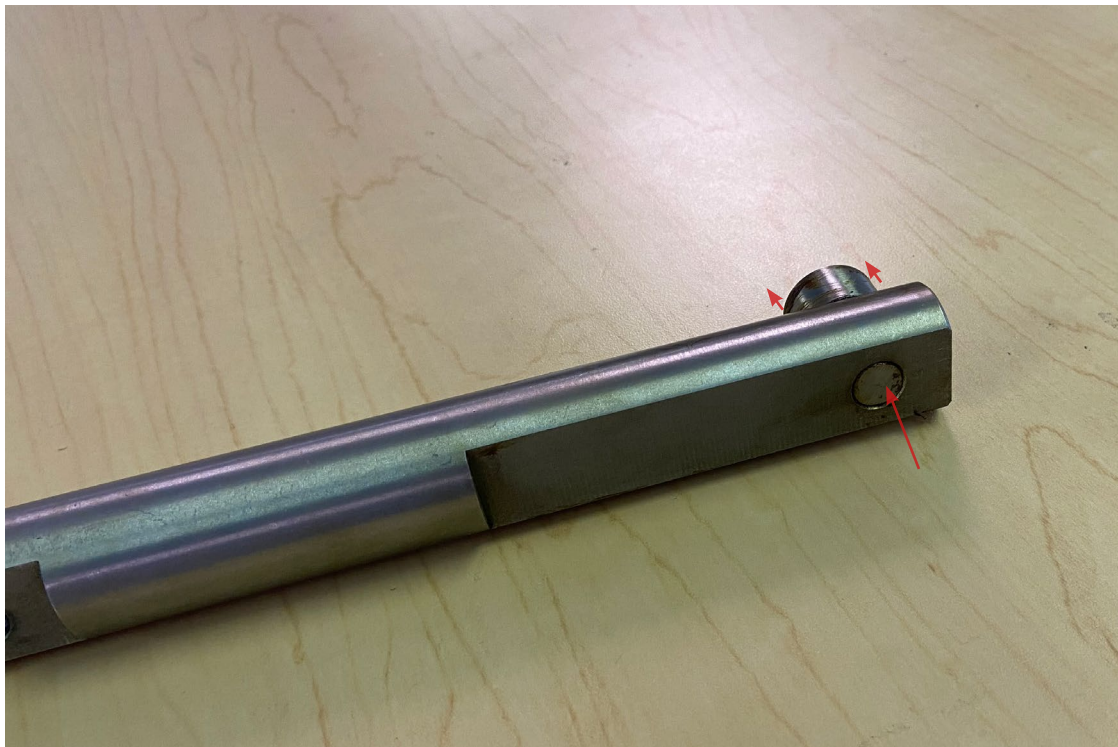

Replace the Boot Timing Bar Runner Bolt

7. Insert the new Boot Timing Bar Runner Bolt into the Boot Timing Bar.

7.1 Note: Use a hammer to ensure that the new Boot Timing Bar Runner Bolt is securely inserted.

8. Tighten the Boot Timing Bar's set screw with an Allen key.

9. Reinsert the Boot Timing Bar with the new Boot Timing Bar Runner Bolt into the Boot Timing Cam.

10. Reinsert the Boot Timing Bar Extender's pin into the bottom of the Boot Timing Bar and secure its set screw with an Allen key.

11. Align the Boot Timing Bar with the base's holes and insert the Boot Timing Bar's pin through them.

11.1 Note: Be sure to reattach the pin's washer and nut.



12. Place back the tablet collector and close the Perspex Doors.

Perspex Door

The Perspex Doors surrounding the tablet press can become cracked, resulting in possible harm to the operator and/or risk of cross contamination. They can be replaced to remedy this issue.

Tools and Materials Needed

- Set of metric Allen keys with ball ends
- Crosshead screwdriver
- Permanent marker
- Power drill
- New Perspex Door
- Disposable latex/rubber gloves (for food grade products and to protect hands from grease)
- Hairnet and/or beard net (food grade products only)
- Sterile shoe covers (food grade products only)



WARNING: To prevent any potential personal injury, ALWAYS unplug the DTP 25[®] from the electrical outlet when replacing parts.

Instructions

Note: Wear latex/rubber gloves (and appropriate food grade attire if applicable) during this process.

Remove the Perspex Door

1. Open the Perspex Doors.
2. Remove all of the screws that attach the Perspex Door to the machine with a crosshead screwdriver.

2.1 Note: Ensure you have a firm grip on the Perspex Door so that it does not fall.

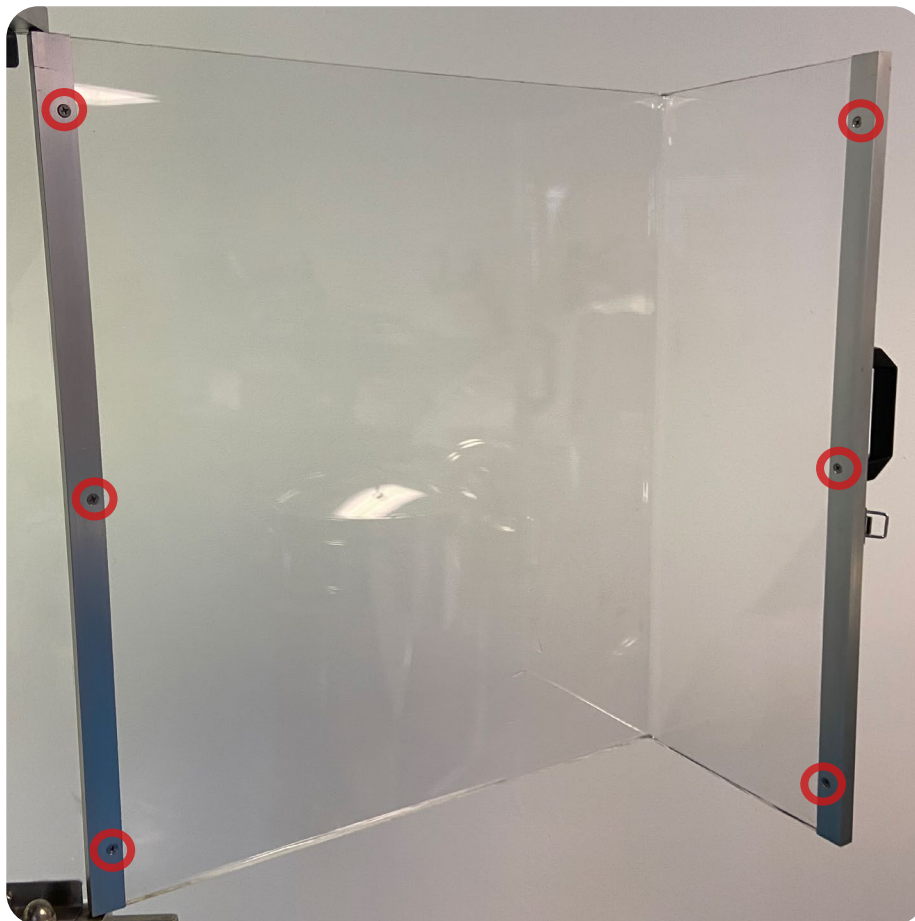

Replace the Perspex Door

3. Insert the new Perspex Door into the metal edge connected to the machine.

4. Mark each screw hole through the metal edge on the new Perspex Door with a permanent marker.

4.1 Note: This indicates the correct locations of the drill holes.

5. Insert the other metal edge with the Handle attached onto the opposite side of the new Perspex Door.

6. Mark each screw hole through the metal edge on the new Perspex Door with a permanent marker.

7. Drill through each of the markings on the new Perspex Door with a power drill.

8. Tighten the screws that were previously removed through the drilled holes on the new Perspex Door and metal edges.

8.1 Note: Ensure you have a firm grip on the Perspex Door so that it does not fall.

9. Shut the Perspex Doors.

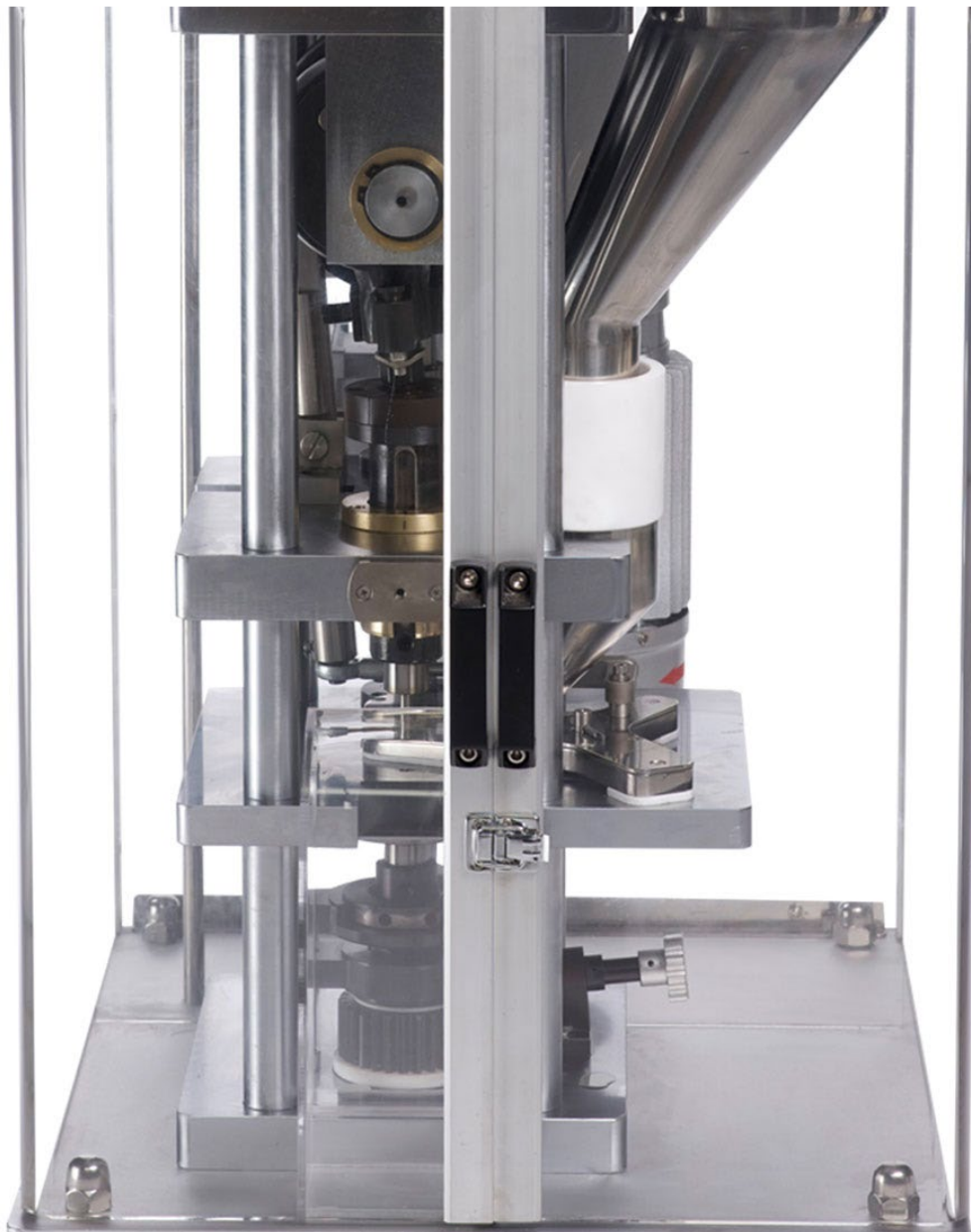

Troubleshooting

Sometimes unavoidable issues will occur while operating the DTP 25[®]. Fortunately, there are several methods to remedy these issues.

Common Machine/Part Issues

Symptom	Possible Cause	Possible Solution
Machine freezes or locks up	Grease point areas are dry.	Regularly oil and grease all the Grease Nipple points.
	There is excess pressure on the Upper Drift Pin Assembly.	Rotate the Upper Drift Pin Assembly counterclockwise.
	The press is being started with the Upper Punch at a low point.	Adjust the starting position so that the Upper Punch is at the highest point.
Knocking sounds coming from machine	The Upper Punch and Lower Punch are colliding with the Die.	After loosening its bolts, readjust the Base Plate until it is correctly aligned. After that, tighten the bolts back.
	The Upper Drift Pin Assembly is slightly off.	Adjust the Upper Punch until it is aligned with the Die's bore.
	The Upper Drift Pin Assembly is not dropping smoothly in the powder filling stage of the process.	Check that there is not a buildup of powder between the Lower Punch and the Die. Then check that the Lower Drift Pin Assembly has enough clearance to drop through the hole in the machine's base.
Heavy resistance during production	The high friction areas are either unclean, locked, worn out, or not greased properly.	Apply grease to the Grease Nipple points and all high friction areas on the machine.

Symptom	Possible Cause	Possible Solution
Inability to compact materials to tablet form	Boot is blocked and not enough materials are flowing out.	Check the Boot for a potential clog.
	The Boot Timing Bar is not secured.	Tighten the Boot Timing Bar's screw.
	There is not enough pressure.	Rotate the Upper Drift Pin Assembly clockwise.
	The Lower Punch is broken.	Remove the Lower Drift Pin Assembly to access the broken Lower Punch. After removing it, replace the Tooling.
	The Lower Drift Pin Assembly is not dropping properly during filling.	Check that there is not a buildup of powder between the Lower Punch and the Die. Then check that the Lower Drift Pin Assembly has enough clearance to drop through the hole in the base.
	There are flowing issues with the mix.	If the machine is able to make tablets with LFA's Firmapress®, then the problem is your mix. Adjust your formulation. If still an issue, contact LFA for support.
Powder sticks to the Upper Punch	There is damage to the Tooling or the Tooling's design is causing sticking.	Remove and replace the Tooling (Upper Punch, Lower Punch, and Die).
	There are issues with the mix.	Adjust your formulation. If still an issue, contact LFA for support.
Powder sticks to the Lower Punch	There are issues with the mix.	Adjust your formulation. If still an issue, contact LFA for support.

Common Tablet Issues

Symptom	Possible Cause	Possible Solution
Double tablets	Previous tablet did not eject correctly.	Remove the double tablet manually from the Die bore.
	Excess granular materials were placed in the Die, which prevented the ejection of the existing tablet.	Clean the Tooling to remove any excess granular materials and make sure that it is clean and completely dry.
Cracked or broken tablets	There are problems with the formulation of the granules and ingredients.	If the machine is able to make tablets with LFA's Firmapress®, then the problem is your mix. Adjust your formulation. If still an issue, contact LFA for support.
	The Boot is not feeding enough material to be pressed in tablet form.	
	There is excess pressure.	Please read our article on Capping at https://www.lfatabletpresses.com/articles/tablet-capping
Shattered tablets	The Boot Timing Bar and the Boot are not adjusted properly.	Adjust the Boot Timing Bar by loosening/tightening its bolt and moving it.
	Air is becoming trapped in the tablet during compression.	Please read our article on Capping at https://www.lfatabletpresses.com/articles/tablet-capping
Inconsistent tablet weight	Not enough pressure is being exerted.	Rotate the Upper Drift Pin Assembly clockwise.
	There are flowing issues with the mix.	If the machine is able to make tablets with LFA's Firmapress®, then the problem is your mix. Adjust your formulation. If still an issue, contact LFA for support.
Soft tablets	There is too little punch pressure.	Rotate the Upper Drift Pin Assembly clockwise.
	There are flowing issues with the mix.	If the machine is able to make tablets with LFA's Firmapress®, then the problem is your mix. Adjust your formulation. If still an issue, contact LFA for support.
Uneven tablets	The Tooling is worn out.	Check the ingredients of your formula before you replace the Die, Upper Punch, and Lower Punch.

De-Jamming the DTP 25[®]

There are several reasons why a DTP 25[®] might jam such as:

- The fill depth is set too low and the pressure is set too high.
- There is a build up of powder sticking to the Tooling.
- Any powder buildup on the machine can cause tablets to eject backwards and not forwards, creating potential for a double tablet becoming stuck in the Die's bore.



WARNING: To prevent any potential personal injury, ALWAYS unplug the DTP 25[®] before de-jamming it.

Tools and Materials Needed

- Set of metric Allen keys with ball ends
- Adjustable wrench
- Disposable latex/rubber gloves (for food grade products and to protect hands from grease)
- Hairnet and/or beard net (food grade products only)
- Sterile shoe covers (food grade products only)

Instructions

Note: Wear latex/rubber gloves (and appropriate food grade attire if applicable) during this process.

Method 1: Lower the Pressure

1. Open the Perspex Doors.
2. Remove the punch pressure adjustment's locking screw with an adjustable wrench.
3. Rotate the Upper Drift Pin Assembly to counterclockwise to decrease the punch pressure.
4. Rotate the press by hand to ensure that it moves freely.

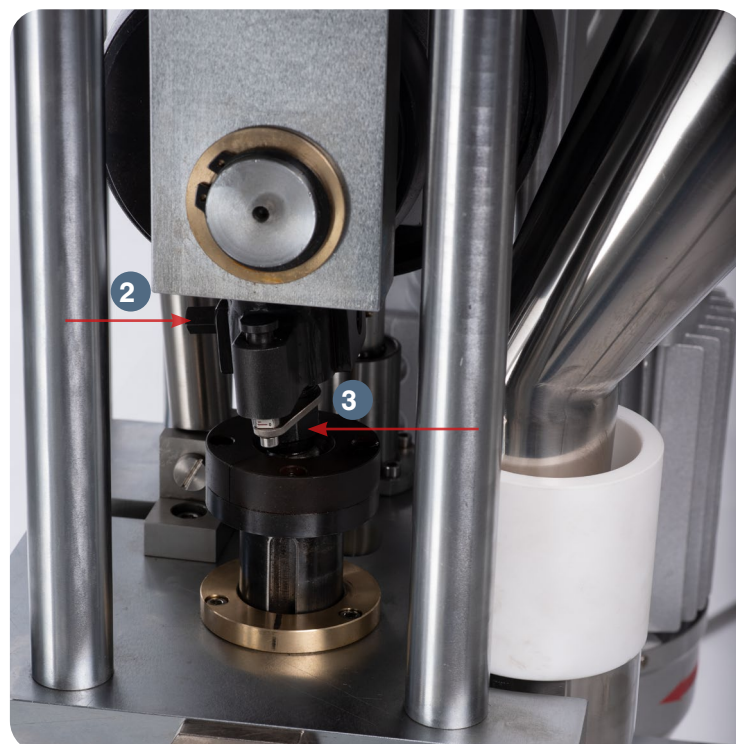

Method 2: Increase the Fill Depth

1. Open the Perspex Doors.
2. Pull the locking handle on the fill depth adjustment away from the machine to loosen it.
3. Rotate the fill depth adjustment wheel clockwise.
4. Rotate the press by hand to ensure that it moves freely.

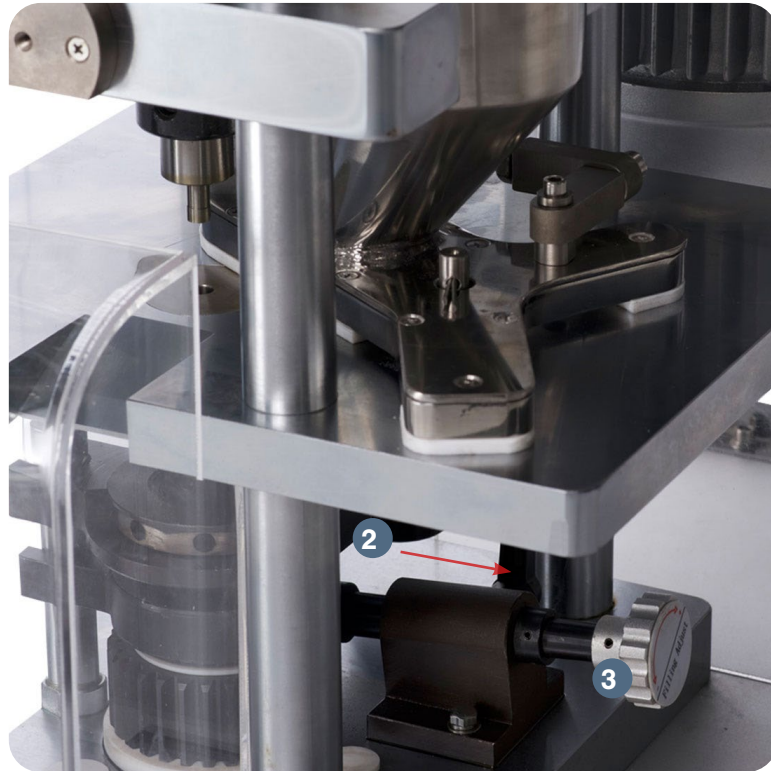

Cleaning

During the DTP 25[®]'s operation, excess powder will find its way into parts of the machine, particularly in the Hopper, Boot, Tooling, and base. It is important to clean the DTP 25[®] thoroughly to prevent rusting and cross contamination.

LFA recommends that the machine be cleaned after each operation.

Tools and Materials Needed

- Cleaning brush
- Long wire pipe cleaner
- Toothbrush
- Cleaner (e.g. Member's Mark Commercial Lemon Fresh Disinfectant)
- Set of metric Allen keys with ball ends
- Disposable latex/rubber gloves
- Bagless vacuum
- 3 clean cloths
- Potable water
- Bowl of warm soapy water (nothing abrasive)
- Sanitizer (e.g. Member's Mark Commercial Sanitizer)
- Hairnet and/or beard net (food grade products only)
- Safety goggles
- Sterile shoe covers (food grade products only)



WARNING: To prevent any potential personal injury, ALWAYS unplug the DTP 25[®] from the electrical outlet when replacing parts.

Instructions

Note: Wear safety goggles and latex/rubber gloves (and appropriate food grade attire if applicable) during this process.

Remove Parts

1. Open the Perspex Doors and remove the tablet collector.
2. Remove the Hopper up through the top of the press and pull off the Hopper Extender from the Boot.

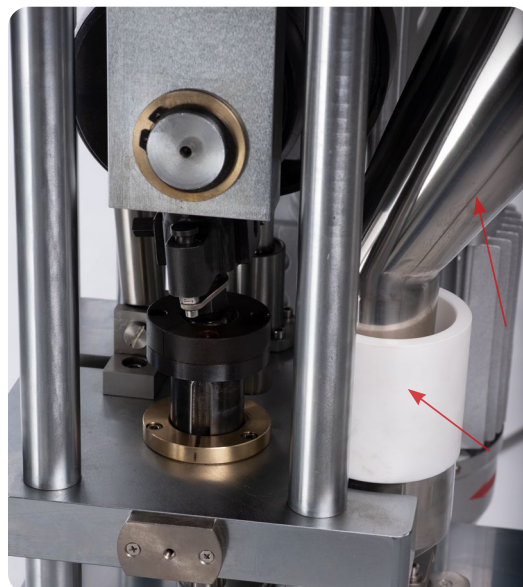

3. Remove the Boot Timing Bar Extender from the Boot with an Allen key.



4. Remove the pin from the Boot Bolt and Spring.

4.1 Note: The Boot Bolt and Spring will fall from the bottom once its pin has been removed.



5. Remove the Boot from the DTP 25®.

6. Remove each of the Boot Teflon Pads underneath with a crosshead screwdriver.

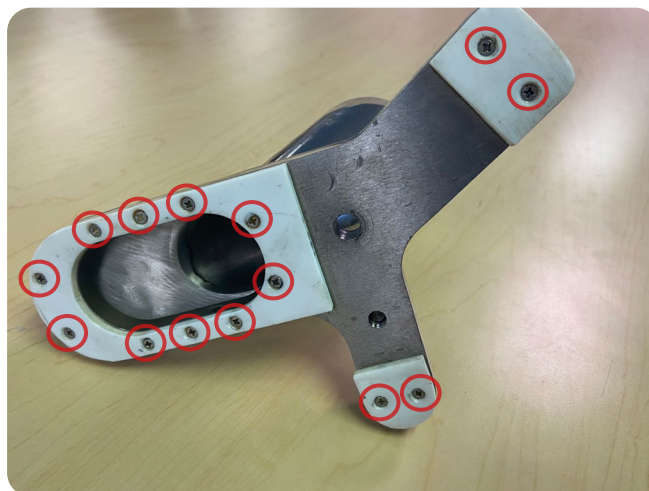

7. Loosen the Upper Punch's bolt with an Allen key and pull out the Upper Punch.

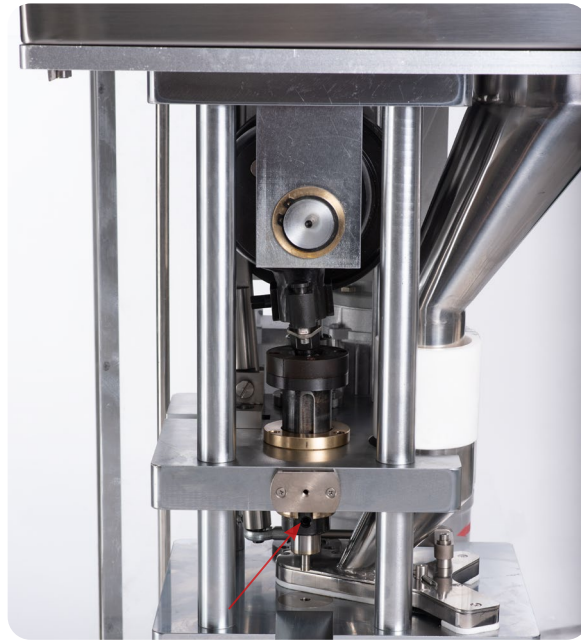

8. Loosen the Die's bolt with an Allen key.



9. Lift up the Die from the DTP 25[®] by hand.

9.1 Note: Lower the ejection height to assist with removing the Die. For further assistance, please refer to the ejection height adjustment instructions on page 17.

10. Loosen the Lower Punch's bolt with an Allen key and remove the Lower Punch.



Note: Before washing the Die plate, LFA recommends using our Die Seat Cleaner. You can order the Die Seat Cleaner and Insertion Ring on our website at <https://www.lfatabletpresses.com/die-seat-cleaner-insertion-ring>



Clean the Base

11. Vacuum any powder/debris from the machine.
12. Spray the DTP 25[®] base with the cleaner, particularly in the Tooling's location.
13. Rinse the cleaner off with potable water.
14. Sanitize the DTP 25[®] base with a clean cloth.

Clean the Parts

15. Take one of the parts removed from the machine and submerge it in the bowl of warm soapy water.
 - 15.1 Note: To ensure that all dirt and debris are removed, wash one part at a time.
16. Take a clean cloth and carefully wash the part thoroughly.
 - 16.1 Note: Use the toothbrush for difficult-to-remove debris. When cleaning tooling, use non-abrasive cleaning equipment such as a soft pipe cleaner and soft cloth.
17. Dry part immediately after it is cleaned and rinsed.
18. Sanitize part with a clean cloth.
19. Repeat steps 15-18 for each remaining part until they are all clean.



Cleaning Schedule Matrix

Part	Frequency							
	After installing machine	After every use	Before every use	In between products that present a cross contamination risk	Weekly	Monthly	Before placing in storage	After removing from storage
Ejection Tray	Remove from machine	Remove from machine	Install on machine	Remove from machine	N/A	N/A	Remove from machine	Install on machine
Tooling	Remove from machine	Remove from machine	Install into machine	Remove from machine	N/A	N/A	Remove from machine	Install on machine
Boot	Remove from machine	Remove from machine	Install into machine	Remove from machine	N/A	N/A	Remove from machine	Install on machine
Base Plate	Remove from machine	Remove from machine	Install on machine	Remove from machine	N/A	N/A	Remove from machine	Install on machine
Hopper	Remove from machine	Remove from machine	Install on machine	Remove from machine	N/A	N/A	Remove from machine	Install on machine
Top Cam area	Clean in machine	Clean in machine	Clean in machine	Clean in machine	Clean in machine	Clean in machine	Clean in machine	Clean in machine
Upper Drift Pin Assembly	Remove from machine	Remove from machine	Remove from machine	Remove from machine	Remove from machine	Remove from machine	Remove from machine	Remove from machine
Motor	Clean on machine	Clean in machine	Clean in machine	N/A	Clean on machine	Clean in machine	Clean on machine	Clean on machine
Upper Drift Pin Assembly Mounting Block	Clean in machine	Clean in machine	Clean in machine	Clean in machine	Clean in machine	Clean in machine	Clean in machine	Clean in machine
Upper Drift Pin Assembly Threaded Cam	Clean in machine	Clean in machine	Clean in machine	Clean in machine	Clean in machine	Clean in machine	Clean in machine	Clean in machine
Lower Drift Pin Assembly	Remove from machine	Remove from machine	Remove from machine	Remove from machine	Remove from machine	Remove from machine	Remove from machine	Remove from machine
Perspex Base	Clean on machine	Clean in machine	Clean on machine	Clean on machine	N/A	N/A	Clean in machine	Clean on machine
Base/Frame	Clean on machine	Clean in machine	Clean in machine	Remove from machine	N/A	N/A	Clean in machine	Clean on machine

Cleaning Level Key	
Level 1 - Remove powder	
Level 2 - Dry clean with cloth	
Level 3 - Dry clean and re-lubricate if specified in lubrication schedule	
Level 4 - Wet clean and re-lubricate if specified in lubrication schedule	
Remove from machine - Take part out of machine and clean if required. Store it correctly or install back into machine.	
Install into machine - Install part into the machine and make sure that it has been cleaned. If needed, lubricate to the level required.	
Clean on/in machine - Clean the part while in the machine and do not remove it. Make sure that all contact surfaces are clean to the level required.	

This cleaning matrix is intended as a guide only and is not an exhaustive list. All cleaning schedules will need to be adapted to the industry and product, following industry regulations and the material safety data sheets that come with specific products. Please check with your Food Safety Manager/Department, Quality Control Manager/Department, or other relevant internal departments at your company before using.

Storing the DTP 25®

After its thorough cleaning, the DTP 25® needs to be stored in the proper conditions. It is important to store it in an environment in which the machine is safe from rusting. The DTP 25®'s high traction areas and the Tooling need to be lubricated separately before you store them.

Tools and Materials Needed

- Plastic wrapping to cover machine
- Airtight container for Tooling (if in storage for more than a week)
- Grease gun
- Lubricant/grease (food grade lubricant if machine has a high chance of contact with the food or drug product)
- Disposable latex/rubber gloves (for food grade products and to protect hands from lubricant)
- Hairnet and/or beard net (food grade products only)
- Sterile shoe covers (food grade products only)

Instructions

Note: Wear latex/rubber gloves (and appropriate food grade attire if applicable) during this process.

Lubricating the Tooling

If you are not using the machine for more than a week, store the Tooling in an airtight container and cover it with lubricant to prevent rust formation. If not, simply lubricate each part of the Tooling and reinsert it back into the machine.

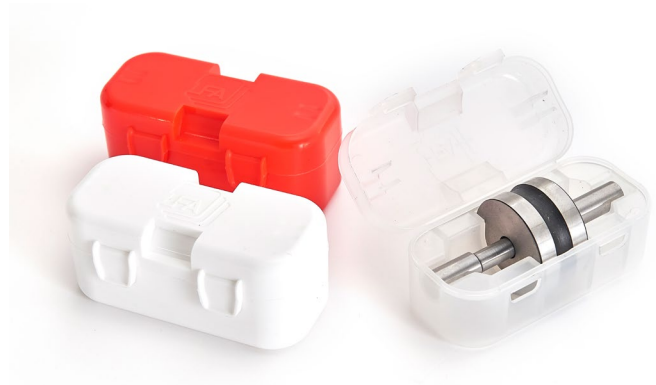

LFA's TDP Tooling Case provides airtight storage and is perfect for transport and protection. Order at <https://www.lfatabletpresses.com/tooling-case-tdp>

1. Rub a finger's worth of grease on the Boot Timing Cam's sides.

1.1 Note: Be sure to lubricate the Boot Timing Cam runner and the Lower Drift Pin Assembly Timing Rod runner.



2. Apply grease to the Eccentric Sheave with a grease gun.
3. Apply grease to the Upper Drift Pin Assembly with a grease gun.

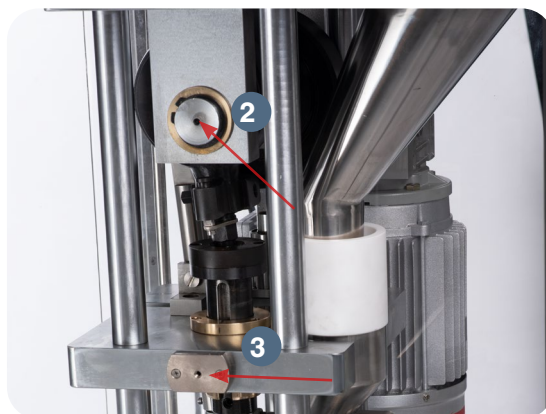

4. Apply grease to the Upper Drift Pin Assembly.



You can also lubricate any point of traction the DTP 25 at your own discretion; just be sure not to over-lubricate.

Cover the DTP 25®

5. Carefully cover the DTP 25® with the plastic wrapping.

5.1 Note: You can use the plastic wrapping that came with the machine in the shipping container.

Environmental Conditions

It is important that the environment in which you store the DTP 25® has the appropriate temperature and relative humidity levels. These two environmental factors can potentially cause the machine to rust and/or cause the tablets to have a lower quality. The table below shows the acceptable temperature and relative humidity levels:

Machine	Temperature		Humidity
	°C	°F	
DTP 25®	18-24	64-75	45-65% RH

Appendix

Glossary

Term	Definition
API/Active Pharmaceutical Ingredient	Any substance or mixture of substances used that is an active ingredient in the drug product.
Binding agent	See excipient.
Die	The part of the Tooling that makes up the hole in which the powder is compressed and shaped into a tablet.
Die bore	The cavity inside the middle of the Die.
Die face	The very top flat surface of the Die.
Ejection height	The height at which the Lower Punch is lifted to for a tablet's ejection from the machine.
Excipient	An inactive substance that serves as the vehicle or medium for a drug or other API.
Fill depth	The amount of space that the powder can flow into in the Die.
Formulation	Powder mix of the excipient and the API that is compressed to make tablets.
Granular material	See Formulation.
Kilonewton (kN)	The force to accelerate a mass of 1 kg at a constant 1 m per second. The TDP range's pressure is measured in this unit.
Punches	The Upper Punch and Lower Punch have concave endings in the shape of the desired tablet. When the punches meet, they compress the powder between.
Punch pressure	The adjustable amount of force that is used to press tablets.
TDP®	LFA trademarked term for desktop tablet press.
Tooling	Enables a tablet press to form tablets. It consists of a Die, Upper Punch, and Lower Punch.

Description of DTP 25® Parts

Tooling

The Tooling consists of the Die, the Upper Punch, and the Lower Punch. This die set compresses the powder into the tablet. Order at <https://www.lfatabletpresses.com/tdp-tooling>

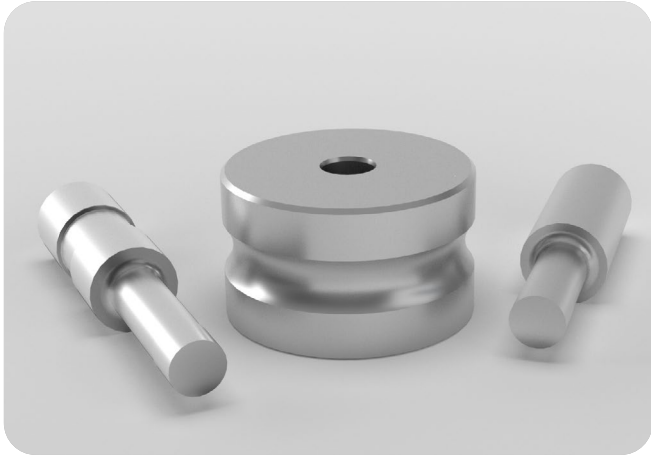

Lower Drift Pin Assembly Cog

The Lower Drift Pin Assembly Cog is used to adjust the tablet's ejection height. It is located in the Lower Drift Pin Assembly. Turning it counterclockwise raises the ejection height, and turning it clockwise lowers it. Order at <https://www.lfatabletpresses.com/lower-drift-pin-assembly-cog-dtp-25>



Boot Timing Cam

The Boot Timing Cam is responsible for the movement of the Boot Timing Bar, which allows the Boot to fill the Die bore with the dry granular materials needed to form the tablet. Order at <https://www.lfatabletpresses.com/boot-timing-cam-dtp-25>

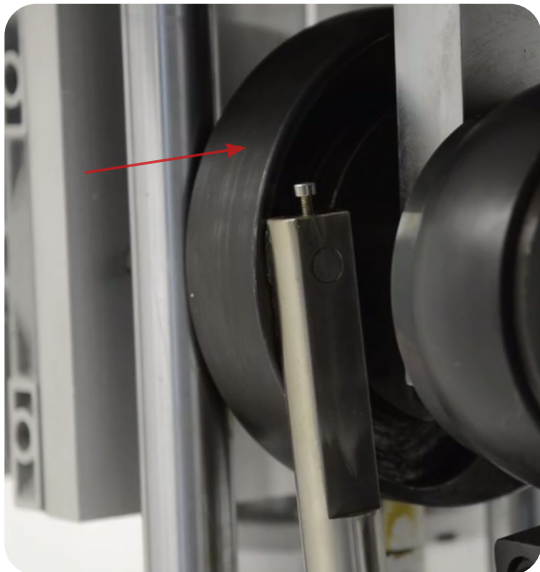

Boot

The Boot is where the dry granular materials are held for pressing. It fills the Die bore with the dry granular material and moves the finished tablet out of the Die before refilling it with the next batch of materials. Order at <https://www.fatabletpresses.com/boot-dtp-25>

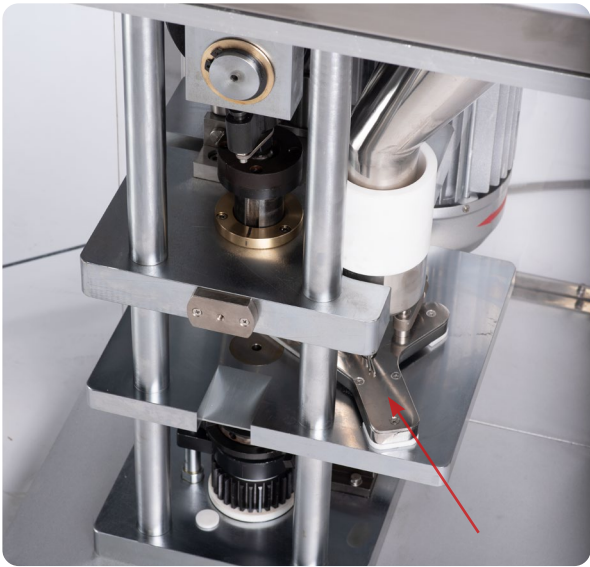

Boot Bolt and Spring

The Boot Bolt and Spring holds the Boot in place while the press is running and allows it to move back and forth. It is kept secure with a pin on top of the Boot. Order at <https://www.fatabletpresses.com/boot-bolt-and-spring-dtp-25>



Hopper

The Hopper is the funnel that holds the granular materials before it moves into the Boot to be pressed.

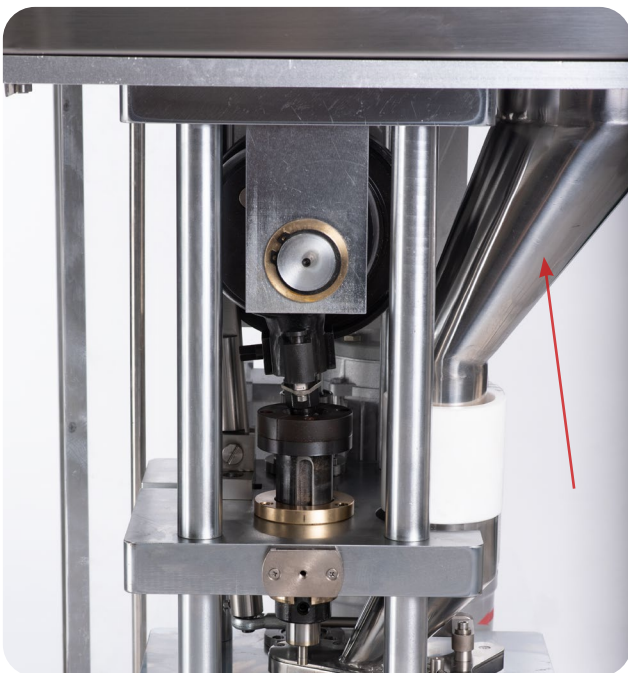

Upper Drift Pin Assembly

The Upper Drift Pin Assembly holds the Upper Punch in place. Order at <https://www.lfatabletpresses.com/upper-drift-pin-assembly-dtp-25>

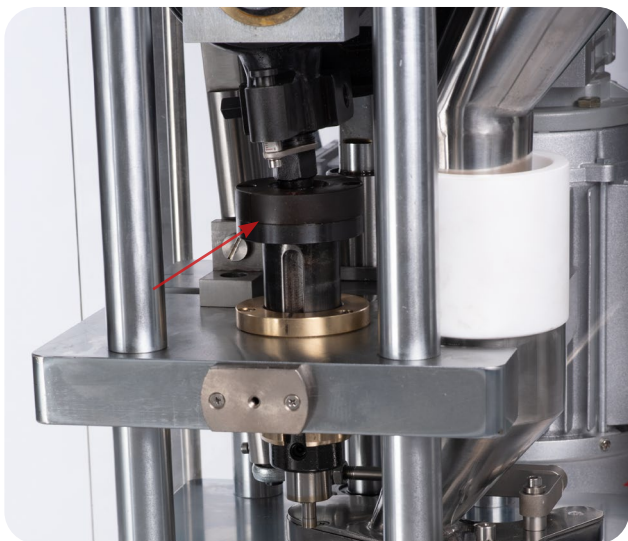

Lower Drift Pin Assembly Timing Rod

The Lower Assembly Timing Rod raises the finished tablet out of the Die. Order at <https://www.lfatabletpresses.com/lower-drift-pin-assembly-timing-rod-dtp-25>



Eccentric Sheave Strap

The Eccentric Sheave Strap attaches the Upper Drift Pin Assembly to the Top Cam. Order at <https://www.lfatabletpresses.com/eccentric-sheave-strap-dtp-25>

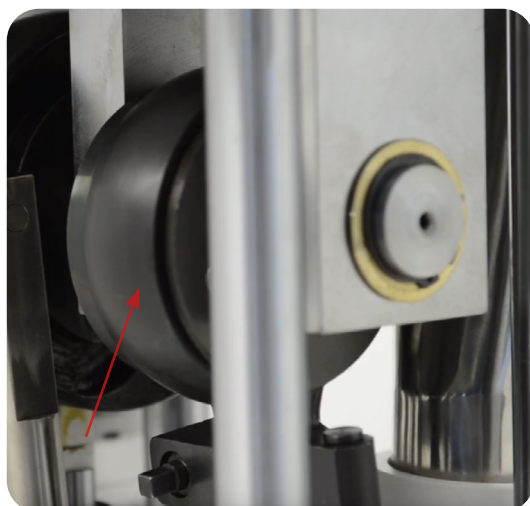

Lower Drift Pin Assembly

The Lower Drift Pin Assembly is located below the base of the tablet. It holds the Lower Punch in place in the Die while the Upper Punch pushes down to form the tablet in the middle. Order at <https://www.lfatabletpresses.com/lower-drift-pin-assembly-dtp-25>



Anti-Vibration Feet

The Anti-Vibration Feet are located on the machine's bottom four corners. They absorb noise and vibration produced by the machine. Order at <https://www.lfatabletpresses.com/anti-vibration-feet-dtp-25>



Boot Timing Bar

The Boot Timing Bar moves the Boot and is timed by the Boot Timing Cam track. The rocking motion that the arm provides helps the Boot to fill the Die bore with the dry granular material for the next tablet. Order at <https://www.lfatabletpresses.com/boot-timing-bar-dtp-25>

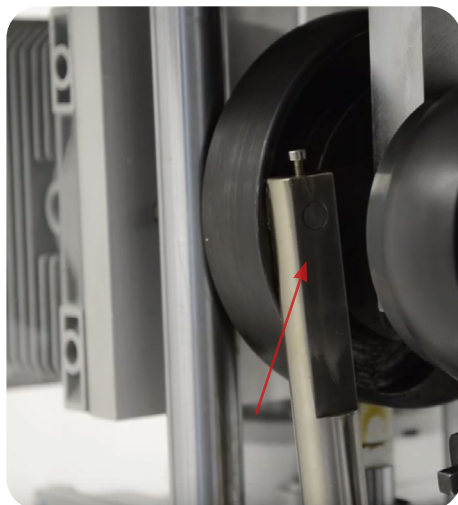

Hand Wheel

The Hand Wheel can be used to turn over the DTP 25[®] manually. Order at <https://www.lfatabletpresses.com/hand-wheel-dtp-25>



Lower Drift Pin Assembly Lifting Bar

The Lower Drift Pin Assembly Lifting Bar lifts the Lower Drift Pin Assembly that holds the Lower Punch and helps push the tablets out of the Die. Order at <https://www.lfatabletpresses.com/lower-drift-pin-assembly-lifting-bar-dtp-25>

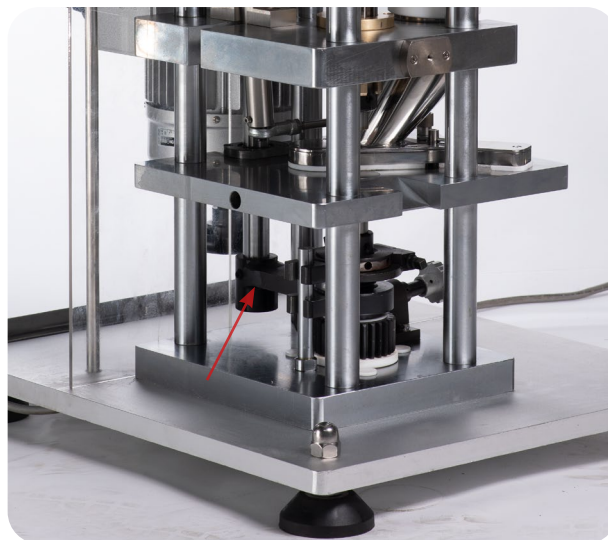

Perspex Door

The Perspex Door is one of the single doors that makes up a casing that covers the upper section of the DTP 25[®] to prevent cross-contamination and personal injury (Handles not included). Order at <https://www.lfatabletpresses.com/perspex-door-dtp-25>



Upper Cam Bushing

The Upper Cam Bushing is a brass wear part that keeps from the upper cam from coming into direct contact with the base of the machine. Order at <https://www.lfatabletpresses.com/upper-cam-bushing-dtp-25>

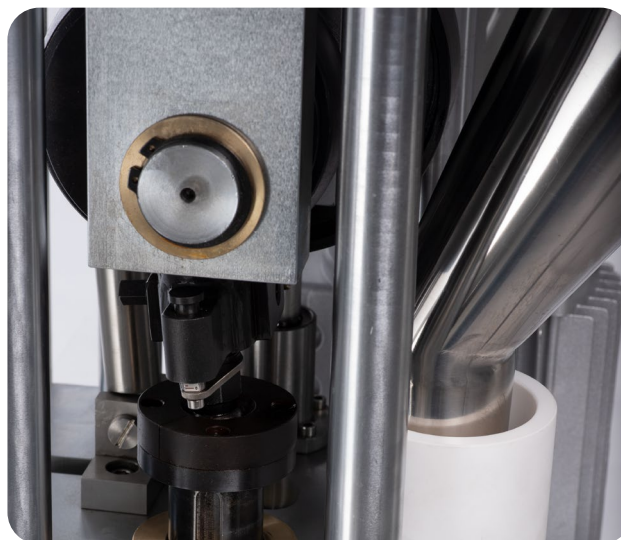

Material of Contact Parts

Contact Part	Material
Boot	304 SS
Frame	304 SS
Tooling (Upper Punch, Lower Punch, and Die)	User specified
Tablet collector	Acrylic
Hopper	304 SS

Technical Specifications

Number of dies	1
Max production capacity	3,600/hour
Max diameter of tablet	25 mm
Max thickness of tablet	8 mm
Max fill depth	20 mm
Max pressure	50 kN
Number of filling stations	1
Double layered tablet	No
Motor power	1.5 kW
Volts	220 V
Overall size	580 mm x 500 mm x 830 mm
Dimensions with suggested working clearance	1480 mm x 1400 mm x 1730 mm
Weight	150 kg (330 lbs)

Maintenance Checklist

Before Operation	
<input type="checkbox"/>	Visually inspect the tablet press and the parts.
<input type="checkbox"/>	Ensure all locking nuts are tight.
<input type="checkbox"/>	Visually inspect grease nipples and regrease where necessary.
<input type="checkbox"/>	Tune the tablet press by hand to get the tablet size and weight correct.
<input type="checkbox"/>	Manually operate the machine for at least two full rotations to ensure it is not jammed.
During Operation	
<input type="checkbox"/>	Listen for irregular knocking or clicking sounds. If heard, stop operation and lubricate the desktop press.
<input type="checkbox"/>	Watch for buildup of powder in front of the Boot. If occurring, either (a) make mix more granular, (b) check the Boot's base for damage, or (c) clear the buildup with a paintbrush.
<input type="checkbox"/>	Occasionally check the Motor's temperature. If it starts to overheat, turn off the machine, let it cool down, and grease it to ensure smooth operation.
<input type="checkbox"/>	Ensure that the Hopper does not run out of powder.
<input type="checkbox"/>	Weigh a sample tablet and test for its hardness.
After Operation	
<input type="checkbox"/>	Unplug machine and remove all excess powder with a bagless vacuum.
<input type="checkbox"/>	Remove the Boot and the Tooling and clean the inside of the tablet press.
<input type="checkbox"/>	Wipe down the other surfaces with a damp cloth.
<input type="checkbox"/>	Apply a layer of food grade grease to the entire desktop tablet press.
<input type="checkbox"/>	Lubricate all grease nipples.
<input type="checkbox"/>	Store Tooling in an airtight box with a small amount of grease.

Diagrams

DTP 25® Display View

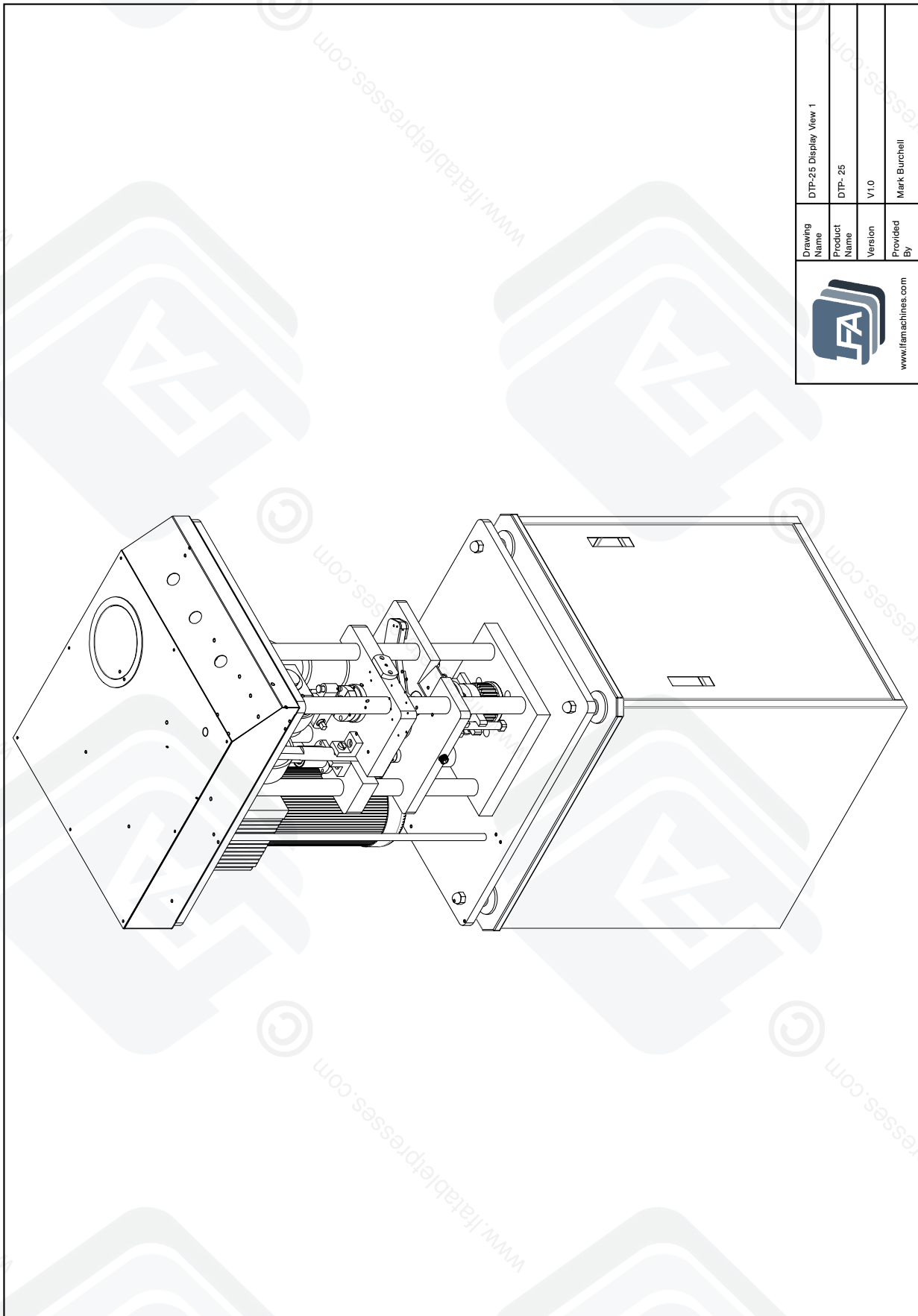

Drawing Name	DTP-25 Display View 1
Product Name	DTP-25
Version	V1.0
Provided By	Mark Burchell

www.famachines.com

DTP 25® Exploding Diagram

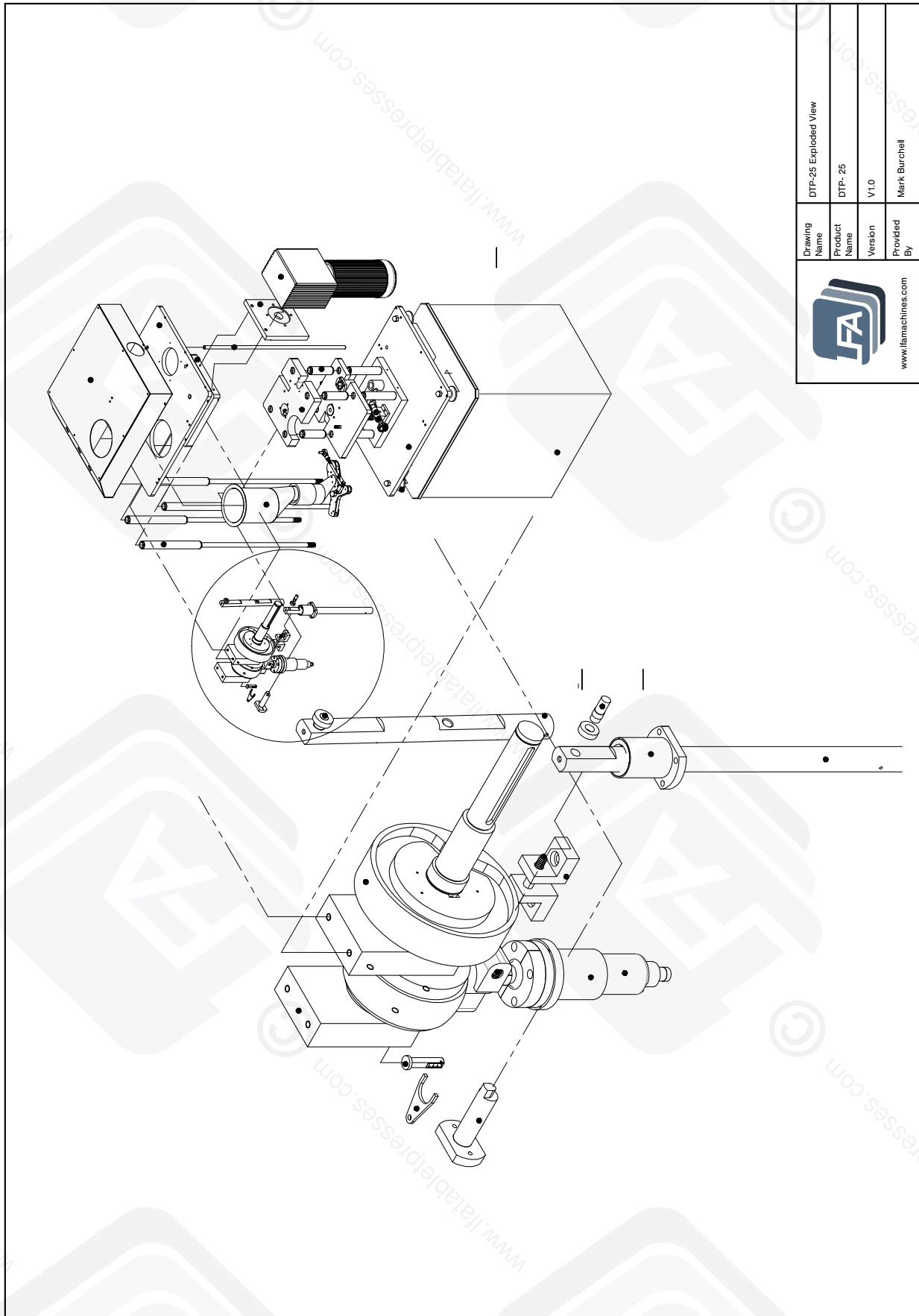

Drawing Name	DTP-25 Exploded View
Product Name	DTP-25
Version	V1.0
Provided By	Mark Burchell



www.famachines.com

DTP 25® Wiring Diagram

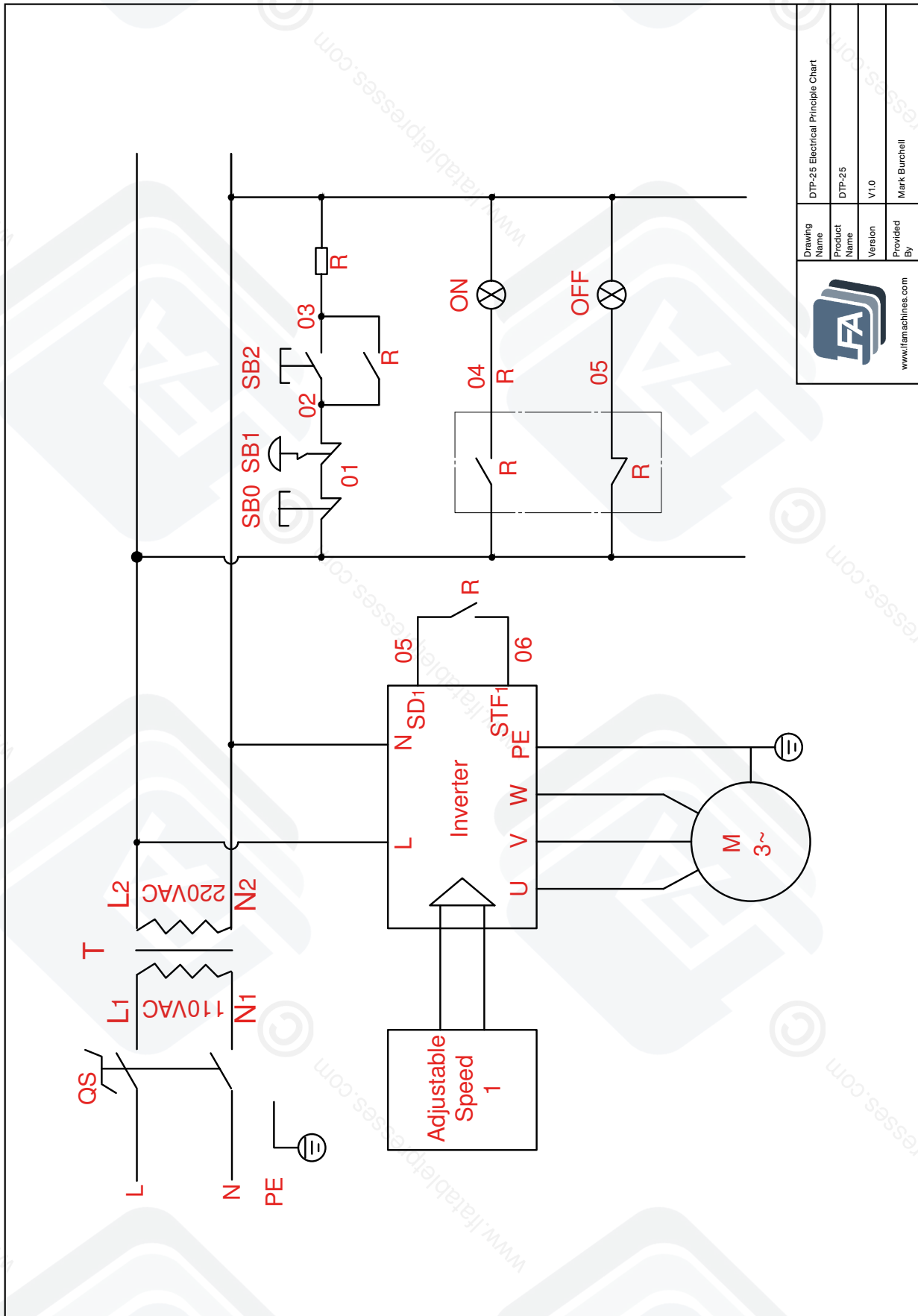

Drawing Name	DTP-25 Electrical Principle Chart
Product Name	DTP-25
Version	V1.0
Provided By	Mark Burchell



www.famachines.com

Resources

Helpful Links

Warranty

For information regarding the warranty policy of the DTP 25[®] and other LFA products, please visit <https://www.lfatabletpresses.com/warranty>

LFA Website

In order to aid you in your tablet production, LFA Machines maintains a website that offers a breadth of useful information about the DTP 25[®] and other tablet presses. Use our online tools such as the Tablet Mix Calculator to help you in your formulation production or read our regularly published articles that cover a whole range of topics about tablet presses and tablet production.

Visit the LFA homepage at <https://www.lfatabletpresses.com>

LFA Machines YouTube Channel

Our YouTube videos provide you an opportunity to see how to use our tablet presses, common troubleshooting tips, and other LFA products such as capsule fillers and mixers. We regularly upload videos to give you a visual aid that will hopefully support you in your tablet production efforts. To watch our videos, visit <https://www.youtube.com/channel/UCwtbcwja77ai7vX2o34FUkQ>

LFA Machines Social Media

Social media is a great way to keep yourself updated on new developments and exciting things happening at LFA Machines. The list below contains our current social media pages:

Twitter: @lfatabletpress

Facebook: <https://www.facebook.com/lfatabletpresses>

LinkedIn: <https://www.linkedin.com/company/lfa-machines-oxford-ltd/>

Contact Us

UK

LFA Machines Oxford Ltd
Unit 4B Rowood Estate
Murdock Road
Bicester, Oxfordshire OX26 4PP
+44 (0) 1869 250 234
sales@lfamachines.com
Monday-Friday
9AM-5PM GMT

US

LFA Machines DFW, LLC
6601 Will Rogers Blvd
Fort Worth, TX 76140
+1 (682) 312 0034
sales.usa@lfamachines.com
Monday-Friday
8AM-6PM UTC (Central)

Germany

LFA Machines Düsseldorf GmbH
Business Parc Am Trippelsberg 92
Düsseldorf, North-Rhine
Westphalia 40589
+41 21188250223
verkauf@lfamachines.com

Taiwan

LFA Machines Taiwan Ltd
7F-5, No. 2, Sec. 2 Taiwan Blvd
West District, Taichung City 403
Taiwan
+886 2773 74704
sales.asia@lfamachines.com



LFA MACHINES

Copyright © 2026 by LFA Machines

www.lfamachines.com

United Kingdom

Unit 4B
Murdock Road
Bicester
Oxfordshire
United Kingdom
OX26 4PP

United States

6601 Will Rogers Blvd
Fort Worth
Texas
United States
76140

Germany

Business Parc Am
Trippelsberg 92
Düsseldorf
Germany
40589

Taiwan

7F.-5, No. 2, Sec. 2
Taiwan Blvd., West Dist.,
Taichung City 403,
Taiwan